



Empowered lives.  
Resilient nations.

الهيئة العامة لشئون ذوي الاعاقة  
Public Authority Of The Disabled



# Kuwait Universal Design Code

October 2017



# Kuwait Universal Design Code

# 1 Content

<b>1</b>	<b>Content</b>	<b>2</b>
<b>2</b>	<b>Introduction</b>	<b>6</b>
2.1	Kuwait's disability and accessibility legal framework	6
2.2	Purpose of the code	7
2.3	Universal Design	7
<b>3</b>	<b>Structure of this Code</b>	<b>9</b>
<b>4</b>	<b>Scope</b>	<b>10</b>
<b>5</b>	<b>Terms and Definitions</b>	<b>11</b>
<b>6</b>	<b>Accessible pedestrian routes.</b>	<b>16</b>
6.1	Resting areas.	19
<b>7</b>	<b>Approaching to the site – Accessibility in the public space</b>	<b>20</b>
<b>8</b>	<b>Kerb ramps specifications</b>	<b>20</b>
<b>9</b>	<b>Pedestrian crossings points</b>	<b>22</b>
9.1	Crossing with kerb ramps	22
9.2	Kerb ramps with flared sides:	23
9.3	Single slope kerb ramp type:	24
9.4	Kerb ramps in kerb extensions	25
9.5	Lowered sidewalk to roadway level	26
<b>10</b>	<b>Pedestrian crossings</b>	<b>27</b>
10.1	Elevated sidewalk	27
10.2	Intermediate islands	28
10.3	Pedestrian crossing signals	30
<b>11</b>	<b>Bollards</b>	<b>30</b>
<b>12</b>	<b>Shaded areas</b>	<b>30</b>
<b>13</b>	<b>Garage entryways</b>	<b>31</b>
<b>14</b>	<b>Parking</b>	<b>33</b>
14.1	Pick-up/Drop-off areas	33
14.2	Accessible parking spaces provision	34
14.3	Accessible parking spaces	34
14.4	Auto-pay machines	35
<b>15</b>	<b>Buildings entrance</b>	<b>38</b>
15.1	Security barriers	39

15.2	Security access systems	40
15.3	Reception areas	40
15.4	Waiting rooms	40
15.5	Electronic queuing systems	41
<b>16</b>	<b>Horizontal circulations</b>	<b>42</b>
<b>17</b>	<b>Protruding objects</b>	<b>44</b>
<b>18</b>	<b>Doors</b>	<b>45</b>
18.1	Door hardware	46
18.2	Manoeuvring spaces	48
18.3	Power-assisted doors	50
<b>19</b>	<b>Glass doors and surfaces</b>	<b>51</b>
<b>20</b>	<b>Window and window hardware</b>	<b>53</b>
<b>21</b>	<b>Handrails and grab bars</b>	<b>54</b>
21.1	Handrails	54
21.2	Grab bars	58
<b>22</b>	<b>Tactile surfaces</b>	<b>59</b>
22.1	Detectable warning surfaces	60
22.2	Tactile guiding surfaces	61
<b>23</b>	<b>Vertical circulations</b>	<b>64</b>
23.1	Elevators	64
23.2	Elevator's doors and lobby specifications	64
23.3	Elevator car features	65
23.4	Lifting platforms	67
<b>24</b>	<b>Ramps</b>	<b>69</b>
24.1	Temporary ramps	72
<b>25</b>	<b>Stairs</b>	<b>75</b>
25.1	Steps	75
25.2	Stair flights	76
25.3	Escalators	79
<b>26</b>	<b>Toilet and sanitary rooms</b>	<b>80</b>
26.1	Accessible urinals	81
26.2	Toilet bowl and seat	82
26.3	Accessible individual toilets	83
26.4	Type A individual toilet, lateral transfer from both sides	84
26.5	Type B corner individual toilet room	85
26.6	Washbasins	86



26.7	Restroom's control and accessories	87
26.8	Toilet rooms doors	88
26.9	Accessible showers	89
<b>27</b>	<b>Family-friendly facilities</b>	<b>91</b>
27.1	Family toilets	92
27.2	Feeding rooms	93
27.3	Child protection seats	95
<b>28</b>	<b>Ablution areas</b>	<b>95</b>
<b>29</b>	<b>Furniture</b>	<b>97</b>
29.1	Accessible chairs and benches	97
29.2	Tables	98
29.3	Drinking fountains	99
29.4	Vending machines, ATMs, Auto-pay machines	100
<b>30</b>	<b>Mosques and prayer rooms</b>	<b>102</b>
<b>31</b>	<b>Entertainment, conferences, lecture facilities</b>	<b>103</b>
31.1	Accessible seating spaces.	103
31.2	Podiums and backstage areas	105
31.3	Box office counters	105
31.4	Study places	106
31.5	Hearing enhancement systems	106
<b>32</b>	<b>Accessible hotel rooms</b>	<b>107</b>
<b>33</b>	<b>Accessible dining rooms</b>	<b>111</b>
<b>34</b>	<b>Accessible workplaces and commercial buildings</b>	<b>113</b>
34.1	Accessible smoking areas	113
<b>35</b>	<b>Shops, supermarkets, shopping malls</b>	<b>114</b>
35.1	Accessible fitting rooms	115
35.2	Lockers	115
<b>36</b>	<b>Accessible changing rooms</b>	<b>116</b>
<b>37</b>	<b>Healthcare and welfare buildings</b>	<b>117</b>
<b>38</b>	<b>Balconies</b>	<b>117</b>
<b>39</b>	<b>Requirements for parks, beaches, natural spaces, outdoors areas</b>	<b>118</b>
39.1	Accessible beaches	119
39.2	Accessible outdoor kiosks	120
39.3	Swimming pools	121
39.4	Outdoor showers	123

39.5	Picnic areas	123
<b>40</b>	<b>Controls and operating mechanisms</b>	<b>124</b>
40.1	Card access	125
40.2	Keypads	125
<b>41</b>	<b>Pedestrian protection on construction works</b>	<b>126</b>
41.1	Scaffolding	128
<b>42</b>	<b>Wayfinding</b>	<b>129</b>
42.1	General	129
42.2	Signage	130
42.3	Directional signs	133
42.4	Identification signs	135
42.5	Tactile maps	136
42.6	Typeface and lettering	139
42.7	High embossment	141
42.8	Braille	142
42.8.1	Position	142
42.9	Accessible information means	144
42.10	International symbol of access	145
<b>43</b>	<b>Emergency preparedness</b>	<b>146</b>
43.1	Fire evacuation for all	146
43.2	Areas of rescue assistance	147
43.3	Panic and emergency exit devices.	147
43.4	Alarms	148
43.5	Evacuation devices	148
<b>44</b>	<b>Management and maintenance</b>	<b>150</b>
<b>45</b>	<b>Anthropometrics, acoustics and lighting</b>	<b>152</b>
45.1	Dimensions and turning areas	152
45.2	Walking and running speed	154
45.3	Acoustics	154
45.4	Lighting	156
<b>46</b>	<b>Table of figures</b>	<b>157</b>
<b>47</b>	<b>Bibliography</b>	<b>162</b>
<b>48</b>	<b>Notes</b>	<b>163</b>

## 2 Introduction

Universal Design has become a national priority for The State of Kuwait. The Kuwait National Development Plan and Actionable vision, includes Universal Design as a main objective. The Kuwait Master Plan is currently under development, this Universal Design Code will be part of its implementation.

### 2.1 Kuwait's disability and accessibility legal framework

Section 5 of the Kuwait's 2010 Disability Law is concerned with societal inclusion. It stipulates in articles 18-23 the need for inclusion in:

- 1) Sports, cultural and entertainment activities by providing accessible environments for PWDs, encouraging them to participate in sports;
- 2) Public buildings and facilities that are designed in line with Universal Design standards;
- 3) In public transport;
- 4) By access to news, cultural programs and parliamentary sessions through sign language as a measure by the Ministry of Information;
- 5) And by launching societal awareness programs for PWDs, ensuring all curricula (educational, religious, life, sports) meets their needs and creating a positive image of PWDs in media.

This document has been developed within the framework of the Project: "Achieving Kuwait 2035 Vision Towards Persons with Disability Project". The project is supported by the United Nations Development Programme (UNDP) Kuwait office, and implemented by the Public Authority for Disabled Affairs of Kuwait (PADA).

The Project seeks to achieve three outputs:

- Output 1.1: Enhanced human capacities and institutional effectiveness for prevention, early detection, diagnosis and rehabilitation of disabilities.
- Output 1.2: Co-ordinated and well organized efficient efforts towards removal of barriers to social, economic and educational inclusion of persons with disability.
- Output 1.3: Increased technical expertise and organizational capacities for implementation of Universal Design and country wide use of technology enablers.

The current Kuwait Universal Design Code will contribute to Output 1.3.

## 2.2 Purpose of the code

The purpose of the Kuwait Universal Design Code is to define how the built environment shall be designed, constructed and managed to enable all users to approach, enter, use, egress from and evacuate independently, in an equitable and dignified manner, to the greatest extent possible.

The requirements in this Code cover a wide range of human abilities, embracing all aspect of life. The requirements of this Code shall be applied at the earliest possible stage in the design process, to avoid higher costs of retrofitting.

This Code's content and its intended application is based on the concept of Universal Design, as described in the following section.

## 2.3 Universal Design

Implementing the principles of Universal Design is the sustainable approach to designing for everyone as it equitably addresses the full life span of individuals as well as environments. This approach is quickly replacing the limited scope and vision of barrier-free design.

The Concept of Universal Design is understood as:

*The design of products, environments, programmes and services to be usable by all people, to the greatest extent possible, without the need for adaptation or specialized design.*

The Seven Principles of Universal Design are:

### 1. Equitable use

The design is useful and marketable to people with diverse abilities

### 2. Flexibility in use

The design accommodates a wide range of individual preferences and abilities.

### 3. Simple and intuitive

Use of the design is easy to understand, regardless of the user's experience, knowledge, language skills, or current concentration level.

### 4. Perceptible information

The design communicates necessary information effectively to the user, regardless of ambient conditions or the user's sensory abilities.

### 5. Tolerance for error

The design minimizes hazards and the adverse consequences of accidental or unintended actions.

## **6. Low physical effort**

The design can be used efficiently and comfortably and with a minimum of fatigue.

## **7. Size and space of approach and use**

Appropriate size and space is provided for approach, reach, manipulation, and use regardless of user's body size, posture, or mobility.

Whereas the focus of an accessible, or barrier-free design, was exclusively on providing appropriate facilities for people with disabilities, commonly represented by wheelchair users only, the universal design concept takes a much broader approach based upon accommodating the diversity of human characteristics within the population as a whole.

A universally designed environment accepts the reality that the broader population comprises of people with a wide range of ages, heights, weights, language skills and abilities. It encourages designers to recognize such diversity within the creative design and planning process, resulting in buildings that are more accommodating and functional for all users – including people who are disabled or elderly.

Throughout our life cycles we all are in constant interaction with the environment in which we live, it is changing all the time. Designers shall recognize this changing dynamic, and plan for it.

The beneficiaries of universal design include, but are not limited to:

- Children
- Elderly people
- People with disabilities
- People from diverse sociocultural backgrounds
- Pregnant women
- Tourists

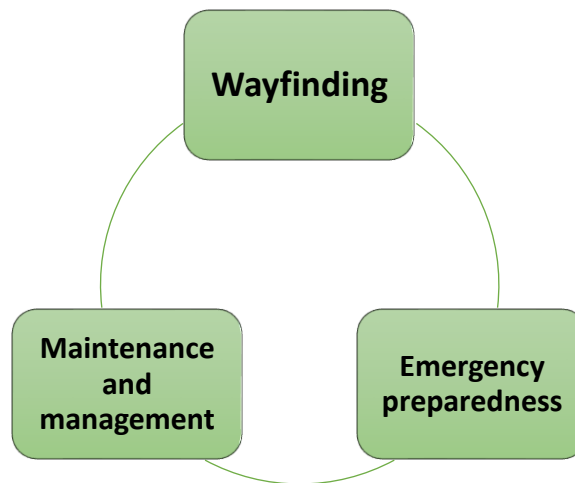
### 3 Structure of this Code

The code has been developed following the logical way of entering and using a building:



Covering the common elements that shall be made accessible under a universal design approach, both outside and inside.

After specifications for architectural elements and individual spaces, the code includes sections that are dedicated to serve all users and beneficiaries of the universal design concept:



At the end of the Code there are also sections for basic anthropometric specifications and bibliography.

## 4 Scope

This Code specifies design and construction requirements for making new buildings accessible to persons with disabilities and other beneficiaries of the universal design concept.

These requirements relate to the external and internal environment, such as right of ways, access to buildings, circulation within buildings, egress from buildings.

The requirements are to be applied during the design, construction, renovations, and alteration of sites, facilities, buildings, and elements of the built environment.

The provisions in this Code are comparable to international standards and are focused on a wide spectrum of people, including parents with children and older persons.

In accordance to similar standards, this Code does not apply private houses, though its provision may apply to public areas of dwelling developments.

Nothing in these requirements prevents the use of designs, products, or technologies as alternatives to those prescribed, provided they result in substantially equivalent or greater accessibility and usability.

The dimensions stated in this Code are primarily based on adult dimensions, nevertheless, it includes specifications that should suit children and people with different heights. If a facility is designed primarily to serve children, dimensions on and other provisions should be adjusted to make them suitable for children.

Dimensions are given in metric units. All dimensions in figures are given in meters or millimetres and are measured to the centreline, unless otherwise specified.

## 5 Terms and Definitions

For the purposes of this Kuwait Universal Design Code, the following terms and definitions apply.

### 1. Access

Approach, entry, internal circulation or exit, including in case of emergency.

### 2. Accessible parking space

Car parking spaces designed with specific criteria for the use of car users with disabilities, that can be either motorists or passengers.

### 3. Accessibility

Accessibility include eases of independent approach, entry, evacuation, and/or use of a building and its services and facilities, by all of the building's potential users, regardless of disability, age or gender with an assurance of individual health, safety and welfare during the course of those activities.

### 4. Accessible toilet compartment

An accessible toilet located in a cluster of toilets on each gender sanitary provision. It features adequate transfer space, toilet bowl, washbasin and grab bars.

### 5. Accessible route

A continuous unobstructed path in an internal or external environment, connecting all accessible elements and spaces in any facility or public spaces.

Interior accessible routes include a combination of the following elements: corridors floors, ramps, handrails, elevators, visual, audible and/or tactile clues, clear floor space, among others.

Exterior accessible include a combination of following elements: accessible pedestrian paths, rights of way, parking spaces, kerb ramps, ramps, lifts, among others.

### 6. Area of rescue assistance

Building space directly adjoining, and visible from, a main vertical evacuation route, protected from hear, smoke and flame during and after a fire, where people can temporarily wait with confidence or further information, instructions, and/or rescue assistance, without obstructing or interfering with the evacuation travel of other building users.



## **7. Built Environment**

External and internal environments, including any element, component or fitting that is commissioned, designed, constructed and managed for use by the people.

## **8. Clear headroom**

Free unobstructed vertical space to allow proper and safe passage.

## **9. Clear width**

Free unobstructed space for access through a doorway, passage, stair, ramp, walkway, etc.

## **10. Colour Blindness**

The most common form of colour blindness is red/green deficiencies in which shades of grey are generally detected in place of red and green. This should be considered when using colour coding or coloured text.

## **11. Disability**

Disability is an evolving concept and that disability results from the interaction between persons with impairments and attitudinal and environmental barriers that hinders their full and effective participation in society on an equal basis with others.

## **12. Escalator**

Moving stairway.

## **13. Evacuation**

Egress in an emergency situation.

## **14. Family toilet**

A public, unisex toilet, available for use by and individual or a family, using any mobility device or pram and an accompanying child, family member, caregiver of the same or opposite sex. Family toilets are accessible toilets that can be used by both genders to allow the greatest flexibility for people who require assistance.

## **15. Fire engineering strategy**

Coherent and purposeful arrangement of fire prevention, fire protection and fire management measures which is developed in order to attain specifier fire engineering design objectives.

## **16. Functional limitations**

Functional limitations are restrictions in performing fundamental physical and mental actions used in daily life such as mobility (physical) or memory (mental).

## **17. Grab bar**

A bar used to maintain balance, providing steadying, stabilizing assistance or support in different locations throughout a building or facility.

## **18. Handrail**

Component of a stair or of a ramp or other building component that provides guidance, balance and support.

## **19. Headroom**

Clear vertical space above one's head, as in a vehicle or room.

## **20. Hearing enhancement system**

Piece of equipment, product system, hardware, software or service that is used to increase, maintain or improve listening capabilities of individuals with hearing impairments.

## **21. Impairment**

Limitation of body function or structure, such as a significant deviation or loss which can be temporary due, for example, to injury, or permanent, slight or severe and can fluctuate over time.

## **22. Individual accessible toilet**

Compartment with the basic requirements of an accessible toilet compartment, that does not require entering to a toilet cluster. It can be placed in both gender sanitary provision or be a unisex room.

## **23. Interaction space**

The interaction space is the space required by a person to interact with another person, furniture, appliance, machine or another item.

## **24. Kerb ramps**

Construction in the form of an inclined plane that makes it possible to pass from street level to a higher accessible pedestrian path.

## **25. Landing**

Platform or part of a floor structure at the end of a flight of stairs or a ramp or at the entrance to a car lift.

## **26. Light Reflectance Value (LRV)**

The proportion of visible light reflected by a surface at all wavelengths and directions when illuminated by a light source. LRV is also known as the luminance reflectance factor. The LRV is expressed on a scale of 0 to 100, with a value of 0 for pure black and a value of 100 for pure white.

## **27. Manoeuvring area**

Minimum three-dimensional spaces within which it is feasible to complete a manoeuvre to gain access to a specific facility, component or fitting, in particular while using a wheelchair or a walking aid.

## **28. Mobility aid**

A device that is used by persons with functional limitations to assist walking. Examples include canes, arm crutches, and walkers. Within this Code the term “wheelchair” is used to include manual wheelchairs, sports chairs, electric powered wheelchairs and mobility scooters, unless otherwise stated.

## **29. Mobility device**

A manual or motorized device to be used by persons with functional limitations in their mobility. Examples include manual and sports wheelchairs, electric powered wheelchairs, and three and four-wheeled mobility scooters.

## **30. Nosing**

Front edge of a tread or landing that protrudes over the riser beneath, that can be rounded, chamfered or otherwise shaped.

## **31. Ramp**

An inclined solid flat plane structure that is steeper than 5 % from the horizontal. Depending on the length it shall include an intermediate landing, which makes it possible to pass from one level to another.

## **32. Rise**

Vertical distance between the upper horizontal surfaces of two consecutive treads, or of a landing and the next treads above or below it, or of a flight between consecutive landings.

## **33. Riser**

Vertical component of a step between a tread or a landing and the tread or a landing above or below it.

### **34. Reflectance**

Measure of light reflected in a given direction by a surface and which is expressed in a unit term from 0 to 100 scale, respectively, that represents a grey scale progression from the notional extremes of total light absorption (black) to total light reflection (white).

### **35. Service animal**

Any guide dog, signal dog, or other animal individually trained to work or perform tasks for an individual with a disability, including, but not limited to, guiding individuals with impaired vision, alerting individuals with impaired hearing to intruders or sounds, providing minimal protection or rescue work, pulling a wheelchair, or fetching dropped items. Service animals shall be identified with a certification.

### **36. Shall**

It is mandatory to do it.

### **37. Should**

It is recommended to do it.

### **38. Street furniture**

Elements located in street and other pedestrian environments, including but not limited to: lamp posts, litter bins, signs, benches, bollards, traffic lights.

### **39. Visual contrast**

Colour and/or tonal contrast between surfaces and fixtures with the purpose of improving visual clarity

### **40. Wayfinding**

Descriptive of a system whereby appropriate information is provided to assist a person to pass through the built environment towards a specific destination. Wayfinding includes orienting oneself, knowing one's destination, following the best route, recognizing one's destination and finding one's way back out. People who are blind or who have a vision impairment benefit from tactile information to facilitate wayfinding.

## 6 Accessible pedestrian routes.

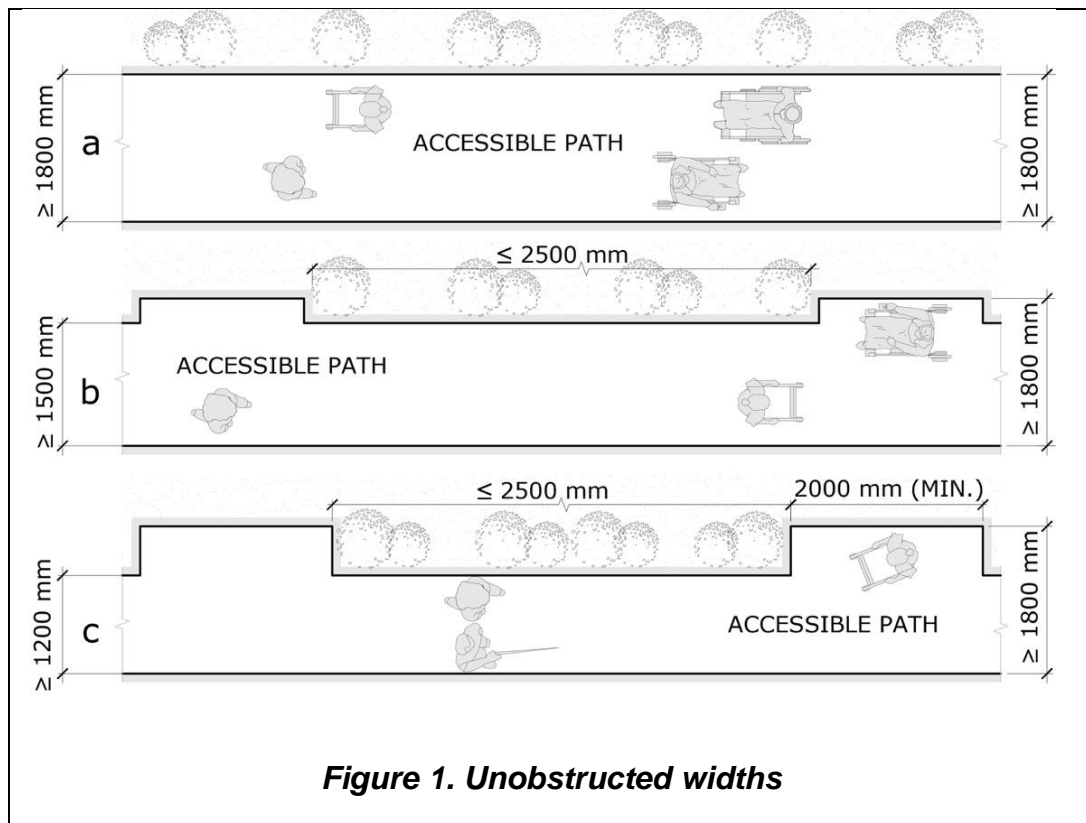
Any accessible pedestrian path that is part of an accessible route, either outdoor or indoor shall:

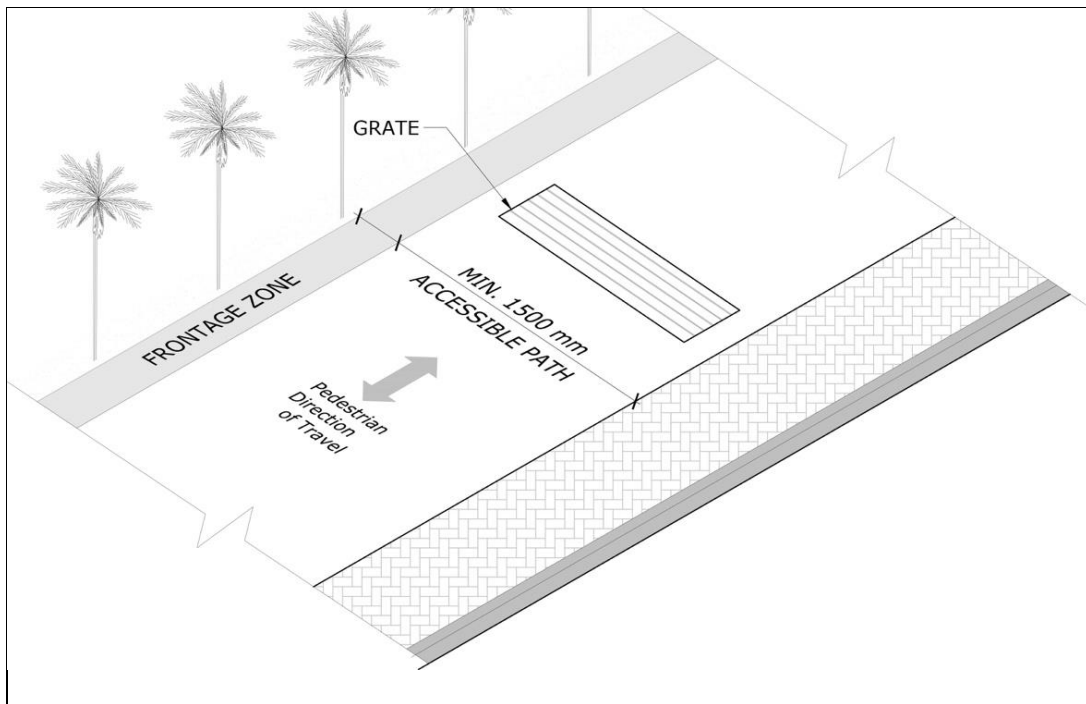
- a) Be level and firm.
- b) Be linear and continued, while avoiding direction changes between pedestrian crossings.
- c) Shall not be interrupted by parking entrances.
- d) Any kerb height along the accessible route shall be between 100 mm and 150 mm.
- e) Preferably intersect at right angles to each other and be easy to follow.
- f) Should have detectable delimitations and different visual contrast from the surroundings.
- g) The maximum permitted gradient for a running slope in accessible routes is 5%. Routes exceeding this gradient shall be considered as a ramp. The maximum cross slope shall not exceed 2%.
- h) Clear headroom along the entire route shall be at least 2200 mm.
- i) Uneven surfaces in accessible paths should be avoided and the maximum height of any irregularity, joints, utility covers or any building element shall be 5 mm.
- j) Gaps and openings on the route sides with a height difference greater than 500 mm should have guardrails.
- k) Luminance along the accessible route shall be at least 100 lux.
- l) Lighting changes along an accessible route shall be gradual to prevent glare.
- m) The floor in indoor routes shall contrast with the surrounding walls in tone and colour. The floor shall present reflectance contrast with the surrounding pavement of at least 30 points LRV (Light Reflectance Value), or by an easily perceptible texture difference. These floors can present less contrast if they are separated by a strip of at least 300 mm presenting the required contrast or by an easily perceptible texture difference.
- n) Contrasting colour strips and detectable warning surfaces shall be placed in changes of level.

- o) Drainage grids or any other type of grate with openings, located on the accessible route shall have perpendicular to the path of travel openings, or with a 12mm maximum.

Shall be free of obstacles or protruding objects, as shown in Figure 1, where the unobstructed width shall be:

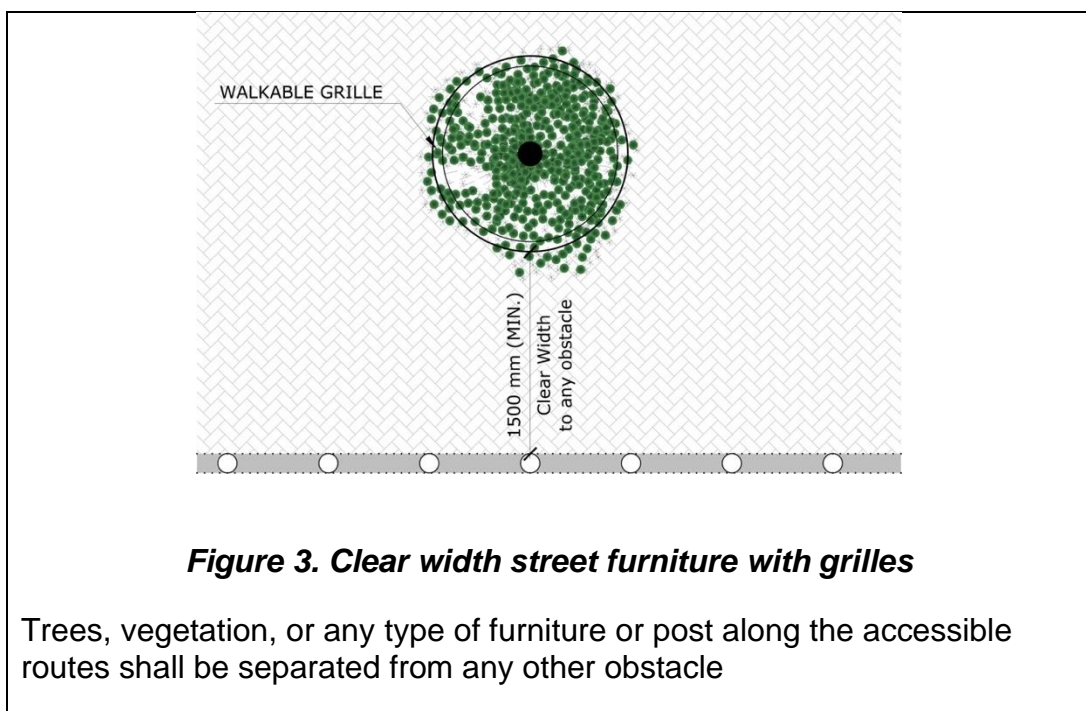
- Not less than 1800 mm for constant two-way traffic
- Not less than 1500 mm for frequent two-way traffic, provided that passing places are included at intervals of maximum 25000 mm
- Not less than 1200 mm for infrequent two-way traffic with a passing and turning space of minimum 1800mm x 2000mm provided each 25000 mm





**Figure 2. Grates in accessible routes**

Grates shall have openings that are perpendicular to the path of travel, or a grilled pattern with openings of 12mm maximum.



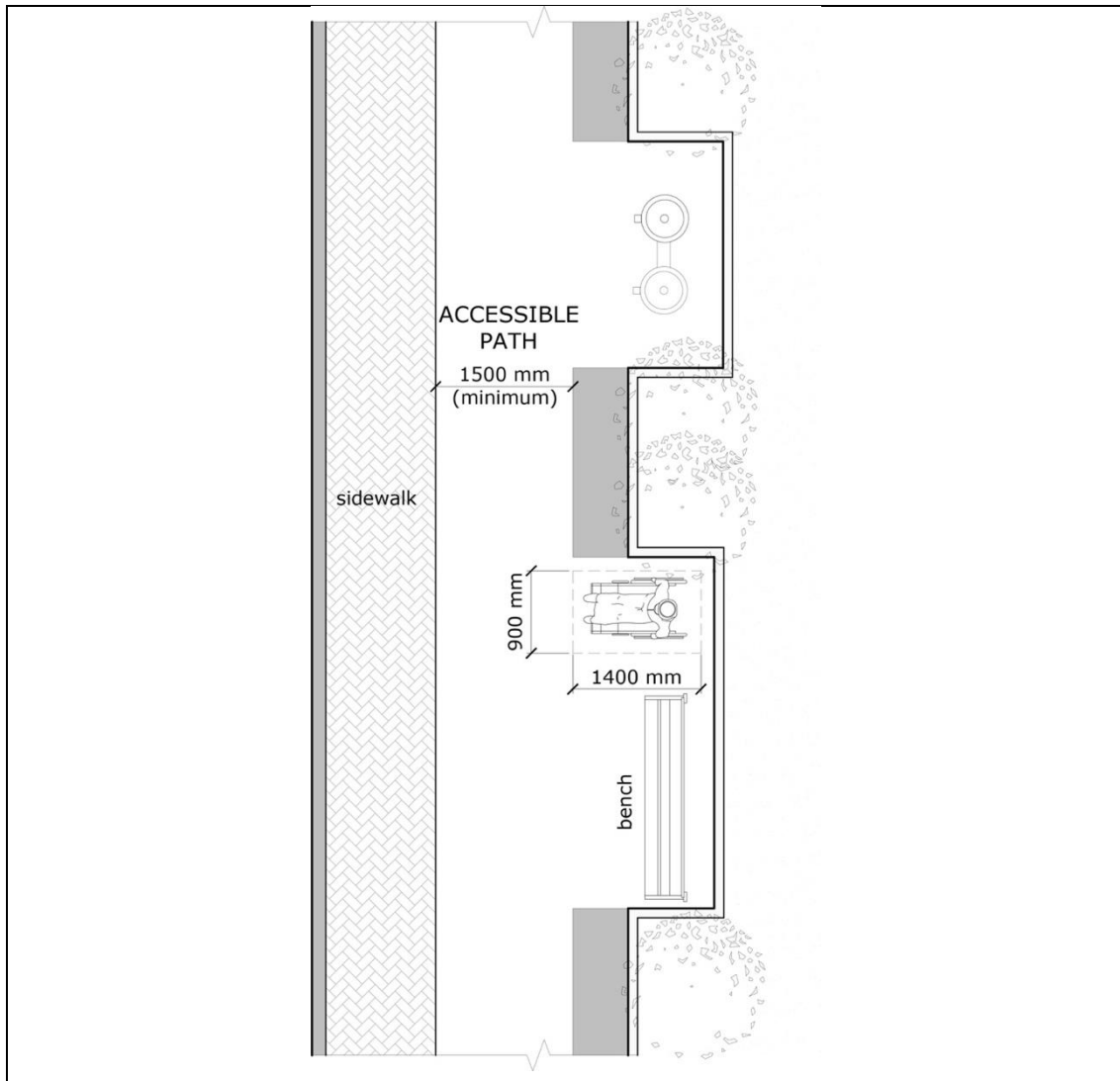
**Figure 3. Clear width street furniture with grilles**

Trees, vegetation, or any type of furniture or post along the accessible routes shall be separated from any other obstacle

## 6.1 Resting areas.

Resting areas with seats shall be provided along the paths of travel, for long travel distances on an indoor or outdoor accessible route. Seat or benches shall be located at intervals not exceeding 50m.

The seat or benches shall have additional clear spaces on either side to allow the location of a wheelchair user, out of the clear path of travel.



**Figure 4. Accessible path with resting area example.**

This diagram shows an example of a recessed resting area with a bench that has additional clear space for a wheelchair user.



## 7 Approaching to the site – Accessibility in the public space

All users shall be able to arrive to the site, approach the building, enter and exit safely and independently. For that purpose, there should be accessible pedestrian routes to, around and between buildings, from the boundary of the site, nearest public transport stop, or from the parking area.

The route approaching the building or facility shall be formed by a combination of accessible routes, pedestrian crossings, stairs, ramps or any other architectural element as per the specifications of this Code.

The number of routes depends on the building or facility design. At least one path of travel shall be accessible route, serving all users.

The accessible route specifications have been described in Section 6. The following sections describe the specification for additional accessible outdoor pedestrian environments.

## 8 Kerb ramps specifications

Kerb ramps must meet the following criteria:

- a) The kerb height shall be between 100 mm and 150 mm, higher kerbs shall be treated as ramps, according to Section 24
- b) Surfaces shall be slip-resistant.
- c) Do not require handrails.
- d) Shall not project onto a road surface.
- e) Shall be located to prevent its obstruction by parked vehicles.
- f) Shall be free from any obstruction, such as signpost, traffic lights, bollards and the like.
- g) The total width of kerb ramps in pedestrian crossings is the same as the width of the accessible pedestrian route, or never less than 2000 mm.
- h) In accessible parking places or drop-off zones, kerb ramps should have a minimum width of 1200 mm or the width of the lateral aisle.
- i) Kerb ramps shall have a warning tactile pavement at 300 mm from the edge.
- j) Kerb ramps edge surfaces shall be completely level with the road.
- k) The colour and texture of the kerb ramps shall be identical to the accessible pedestrian route.

- l) Shall have a detectable warning surface 400 mm depth with contrasting colour and texture
- m) Slip resistance value shall be higher than 45 PTV, as indicated in section 5.2.
- n) The maximum cross slope gradient maximum is 2%.
- o) Kerb ramps must not interfere with the accessible route.
- p) When the kerb ramp design causes a step in its lateral edges, this level change should be protected by some element or urban furniture.
- q) Kerb ramp located on both sides of a street must be aligned.
- r) Drain grids shall never be located on the kerb ramp landings.
- s) The maximum running gradient is 8% depending on the height of the sidewalk the length will vary following Table 1.

Table 1. Kerb ramps<sup>i</sup>

Sidewalk height	Ramp run dimensions			Flared sides	
	Length	Width	Max. gradient	Length	Max. gradient
<b>100 mm</b>	1250 mm	Equal to crossing painting >2,00m	8%	1250 mm	8%
<b>150 mm</b>	1875 mm			1875 mm	
<b>200 mm</b> <b>(only for existing sidewalks)</b>	2500 mm			2500 mm	

## 9 Pedestrian crossings points

The following are suggested layouts for pedestrian crossing points, involving kerb ramps or elevated sidewalks.

### 9.1 Crossing with kerb ramps

When using kerb ramps to cross streets, the roadway shall maintain a continuous level and non-slippery surface.

The crossing shall fulfil the following requirements:

- a) There is a kerb ramp at each end of the pedestrian crossing to connect the sidewalk and the roadway.
- b) There are no level changes at both ends of the kerb ramp and flush with the sidewalk and roadway
- c) The kerb ramps on each end shall be aligned.
- d) The sidewalk edge of the pedestrian crossing should be marked with a strip of tactile warning pavement. This tactile pavement should run all the width of the kerb ramps and shall fulfil the requirements of this code.

The suggested kerb ramp types are described below.

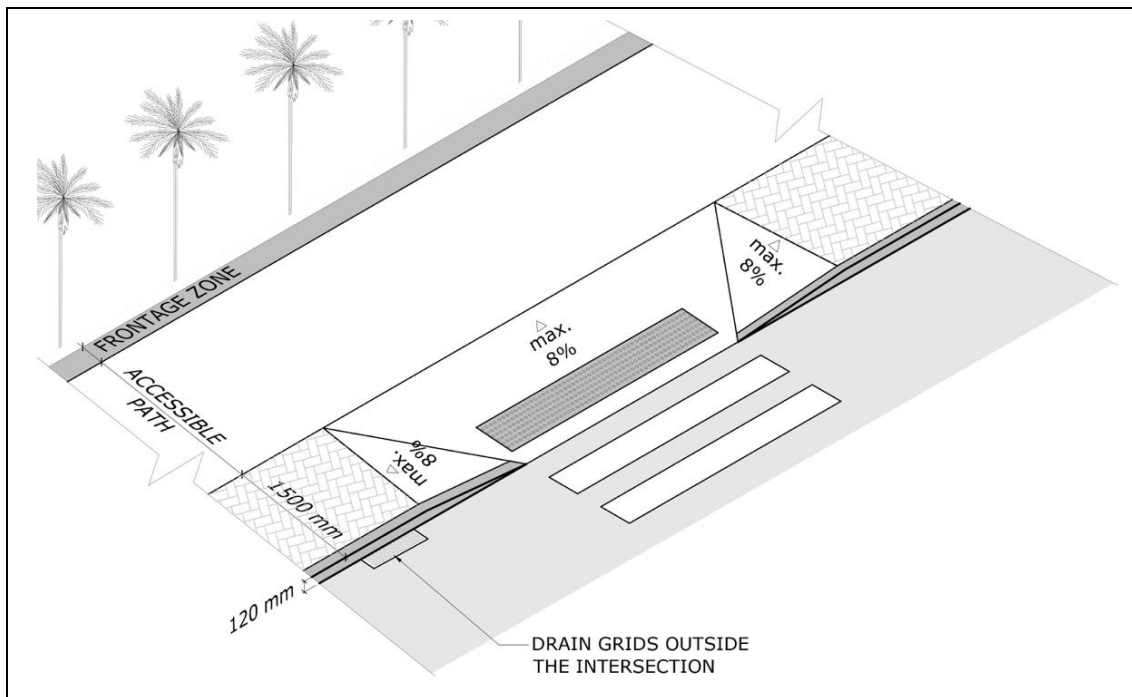
## 9.2 Kerb ramps with flared sides:

Kerb ramps with flared sides are the most common type, and are comprised of three slopes.

All gradients shall be a maximum of 8%. This type of Kerb ramp is preferred where pedestrians are likely to walk across them.

Depending on the kerb's layout, and adapting to local conditions, the flared sides of kerb ramps can have higher cross gradient slopes, but never more than 12%.

There should be a clear landing space on the sidewalk side of the same width as the accessible path, but no less than 1200mm.



**Figure 5. Kerb ramp with flared sides**

This type of kerb ramp is better suited for wide sidewalks with plenty of room for providing an adequate gradient for the ramp and flared sides

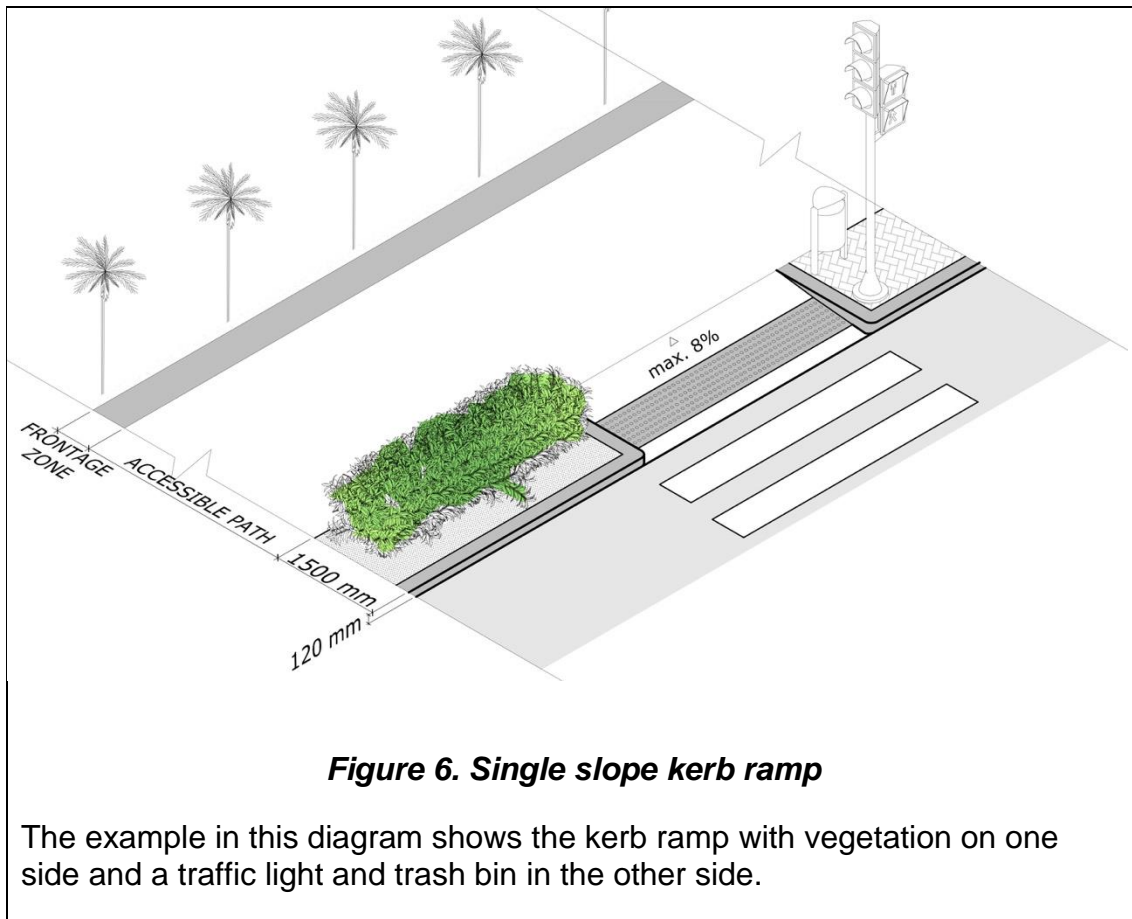
### 9.3 Single slope kerb ramp type:

Single slope kerb ramps are comprised of a single slope placed longitudinally on the crossing direction, linking the sidewalk with the roadway.

This type of kerb ramps shall be used where there is not enough room for providing adequate flared sides, or where street furniture of any kind prevent providing the flared sides.

The sides of the kerb ramp shall have any of the following elements:

- Vegetation
- Street furniture, such as waste bins, traffic or pedestrian lights, street lamps, bollards, etc.

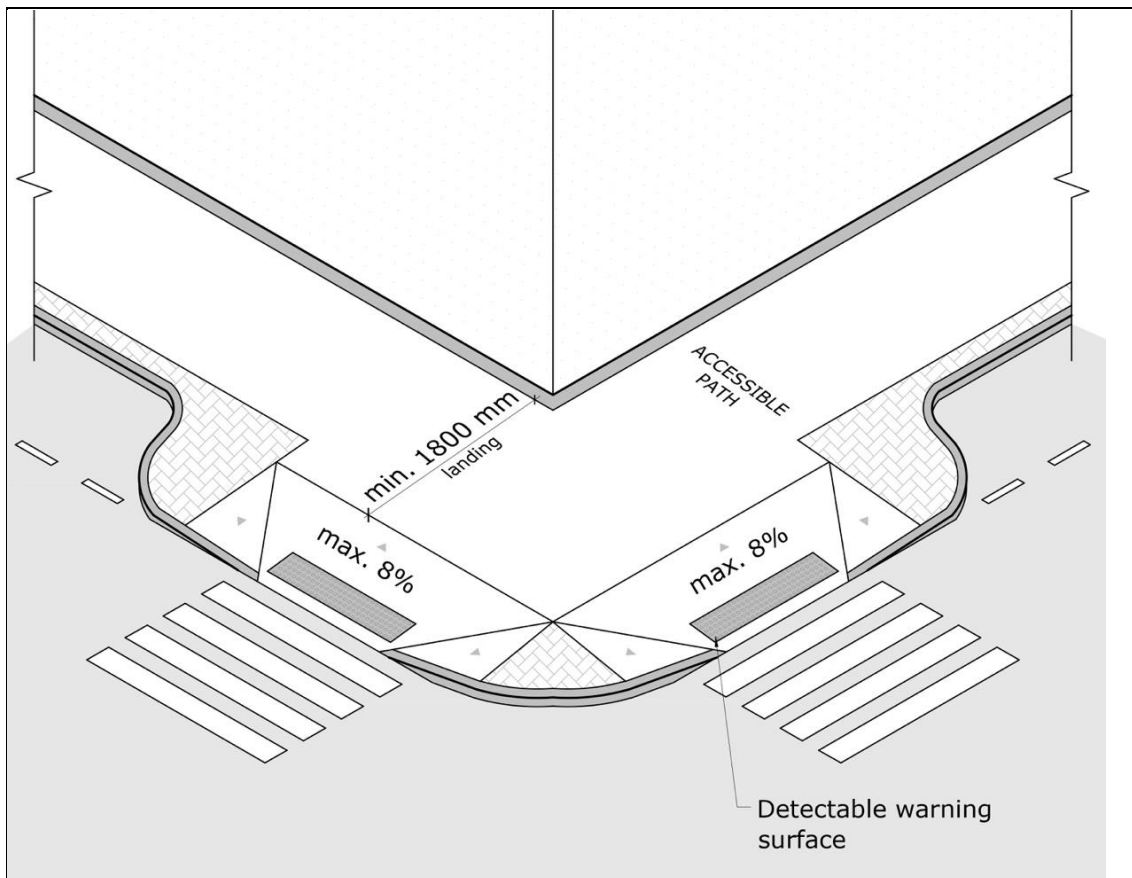


## 9.4 Kerb ramps in kerb extensions

This type is appropriate when the sidewalk is narrow with no space in the corners for the pedestrians to wait, or the roadway is too wide to provide a short crossing time.

Extensions in the street corners can be created to reduce the pedestrian crossing distance. The kerb extensions can have street furniture or vegetation, provided the accessible routes and kerb ramps are free of any obstacle.

Kerb ramps of any kind can be used on the extension.



**Figure 7. Kerb ramp in kerb extensions**

This example shows to flared sides kerb ramps on the kerb extension.

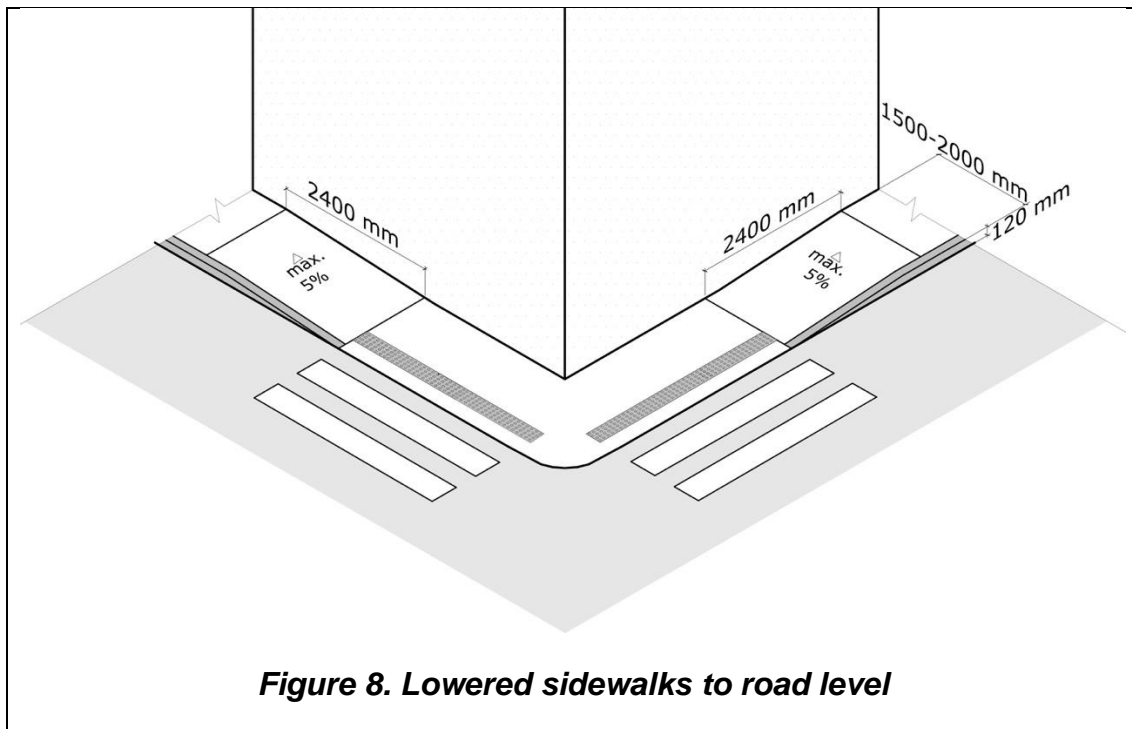
## 9.5 Lowered sidewalk to roadway level

Lowering the full width of the sidewalk to the roadway level should be implemented when the sidewalk width is too narrow to use any other type of kerb ramp.

This crossing is comprised of two running slopes that lower the sidewalk's full width to the roadway level at the corner, providing crossing paths in both directions

A minimum 2000 mm long landing should be provided between the two slopes. The edge of the landing with the roadway shall have a tactile warning pavement to provide a reference of the change between the sidewalk and the roadway.

A maximum gradient of 5% shall be provided on the ramps used for this crossing point.



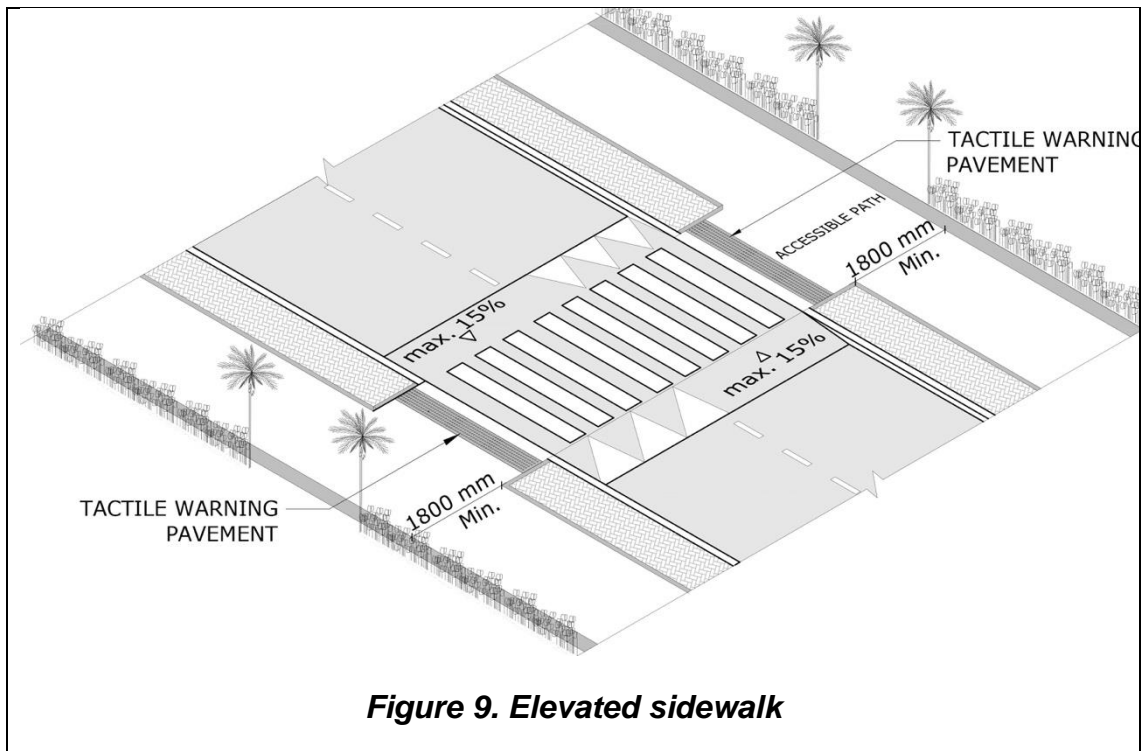
## 10 Pedestrian crossings

### 10.1 Elevated sidewalk

The sidewalk shall maintain a continuous surface without lowering to the roadway level during the crossing.

Shall fulfil the following requirements:

- The total width is the same as the crosswalk width, or at least 2000 mm, free of any obstacle.
- The surface height shall be between 100 mm and 150 mm above the road, and the longitudinal gradient of the roadway ramp cannot exceed more than 15%.
- The crosswalk is marked on the raised surface for all its width.
- The sidewalk edge of the pedestrian crossing shall be marked with a strip of detectable warning surface. This tactile warning surface shall run the width of the crossing and shall fulfil the requirements established in this code.
- Drainage should be resolved without causing a level change, a step or a gap across the crosswalk.



**Figure 9. Elevated sidewalk**



## 10.2 Intermediate islands

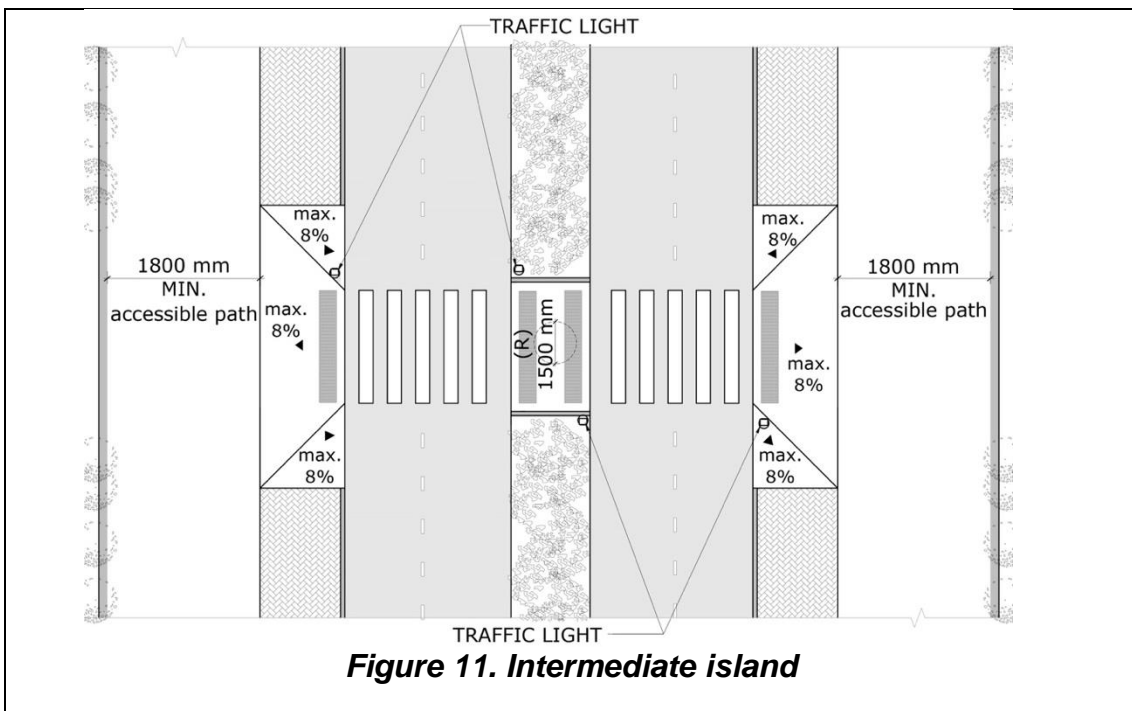
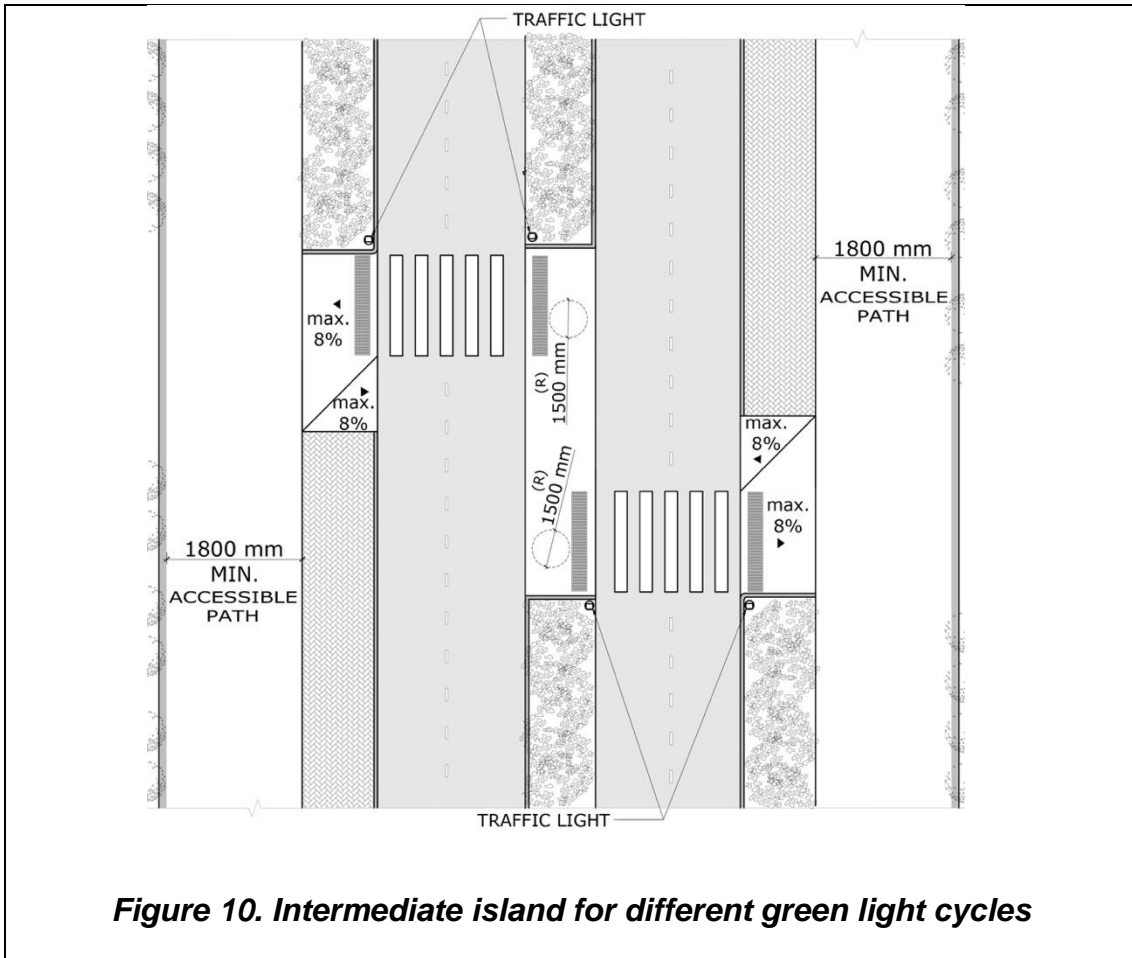
Pedestrian crossings may have intermediate islands due to the roadway length or to provide a suitable time for crossing.

The intermediate islands shall fulfil the following requirements:

- a) The width of the island shall be at least 1500 mm.
- b) The island pavement shall be the same colour as the pedestrian path. Both island edges should be marked with detectable warning surface at least 300 mm wide and the same width as the pedestrian crossing.
- c) When two traffic directions are separated by an intermediate island and have different green light cycles, pedestrians should be required to wait in the central island for the green light and guardrails shall be placed to guarantee that pedestrians stop in the island.

The offset intermediate islands should fulfil the following requirements:

- a) The entrance and exit of the pedestrian crossing at the intermediate island shall be misaligned.
- b) The path between the entrance and the exit shall be protected on both sides with guardrails, dwarf walls or other protection elements.
- c) The island pavement should be the same colour as the pedestrian path. Both island's edges should be marked with detectable warning surface of at least 300 mm wide and the same width as the pedestrian path.



### 10.3 Pedestrian crossing signals

Accessible pedestrian signals on the accessible pedestrian crossing shall provide visual and audible signals that provide information on the crossing cycle and duration, providing at least:

- a) On-demand acoustic signals: activated by user demand by touching a button. It should have a distinctive tone and duration.
- b) Pedestrian crossing signals: automatically emitted during the pedestrian crossing cycle and maintained throughout the cycle. It has a distinctive tone and changes when finishing the crossing time.
- c) The sound shall be set to last for the full traffic light cycle.

The pedestrian signal pushbutton for activating an on-demand crossing signal shall be mounted at a height between 900 mm and 1200 mm and should have tactile characters.

### 11 Bollards

Whenever bollards shall be used, they shall comply with the following requirements:

- a) Have a minimum clear distance of 900mm between the bollards.
- b) Not be linked with a chain or ropes.
- c) Have a minimum height of 800 mm.
- d) Have colour contrast with the background.
- e) Without objects protruding horizontally.
- f) Be well lit with light positioned in a way to prevent glare.

### 12 Shaded areas

The provision of continuous shaded pedestrian paths is encouraged along accessible routes. In case a continuous shading is not feasible, shaded areas shall be provided at least every 50 m along accessible routes.

Each second shaded area shall be provided with seating places and adequate space for wheelchair users.

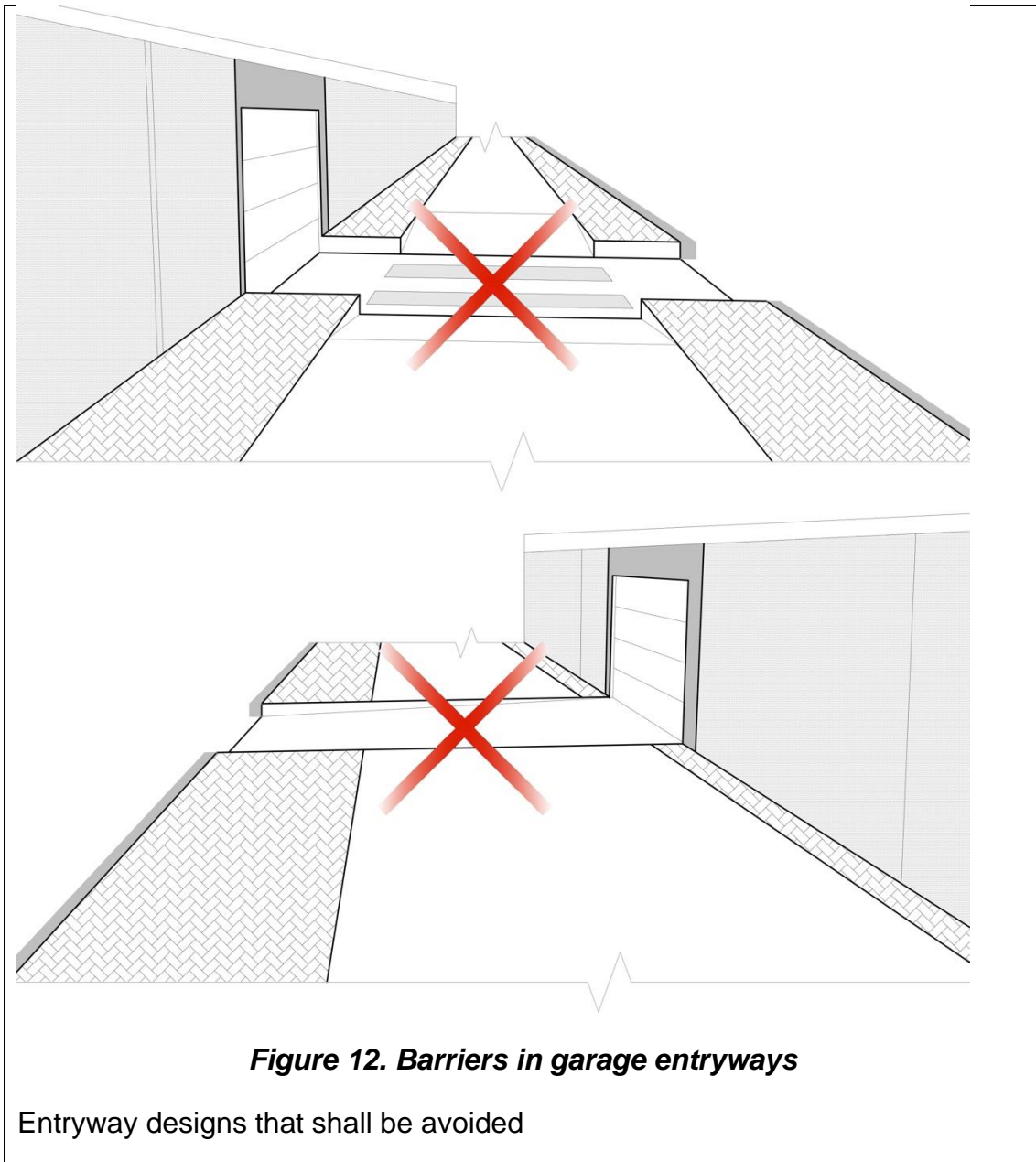
Shade may be provided by means of trees, pergolas, retracted facades or any other architectural element that comply with the accessibility provisions of this code.

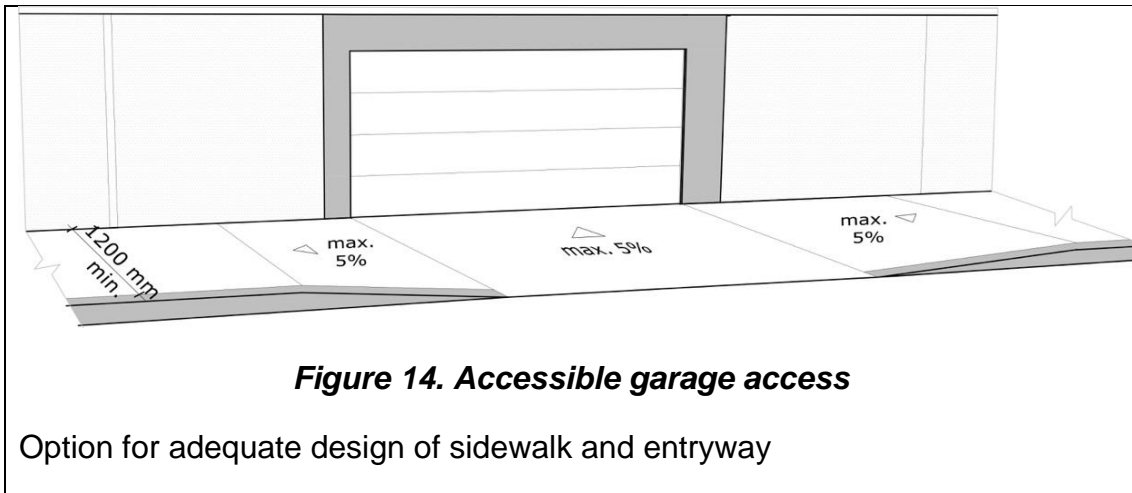
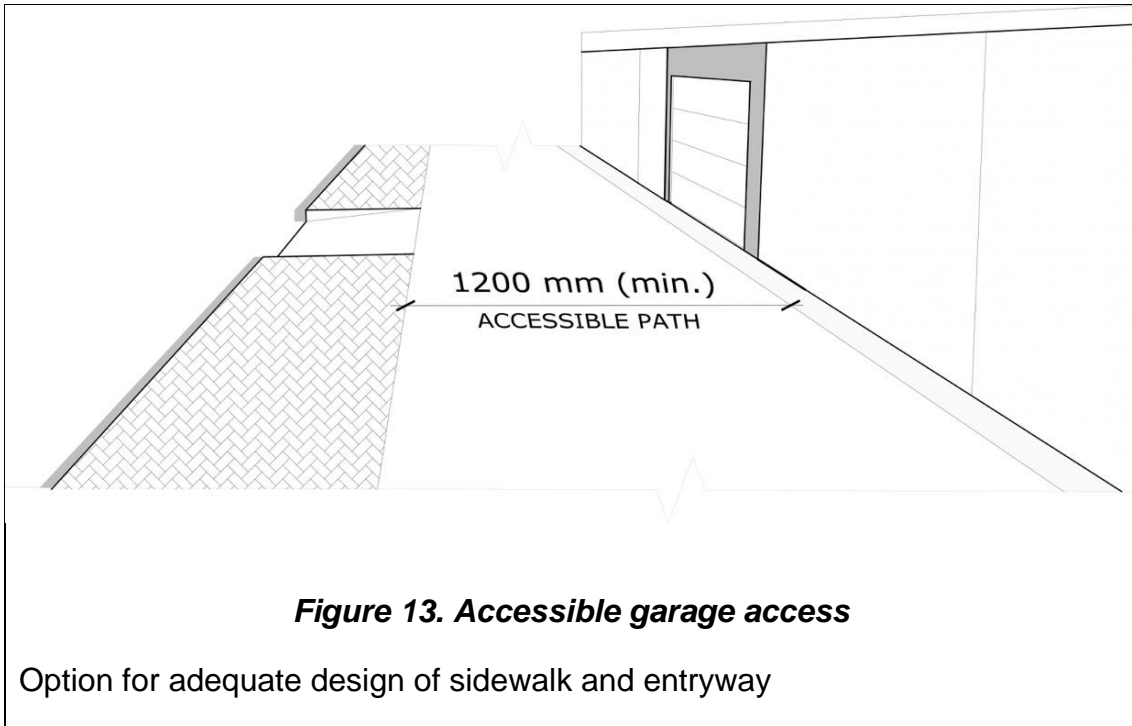
### 13 Garage entryways

Garage entryways to any building or facility shall not interrupt a sidewalk or accessible route.

Figure 12 shows the designs that shall be avoided.

Figure 13 and 14 show examples of adequate accessible routes on the intersection with garage entryways.



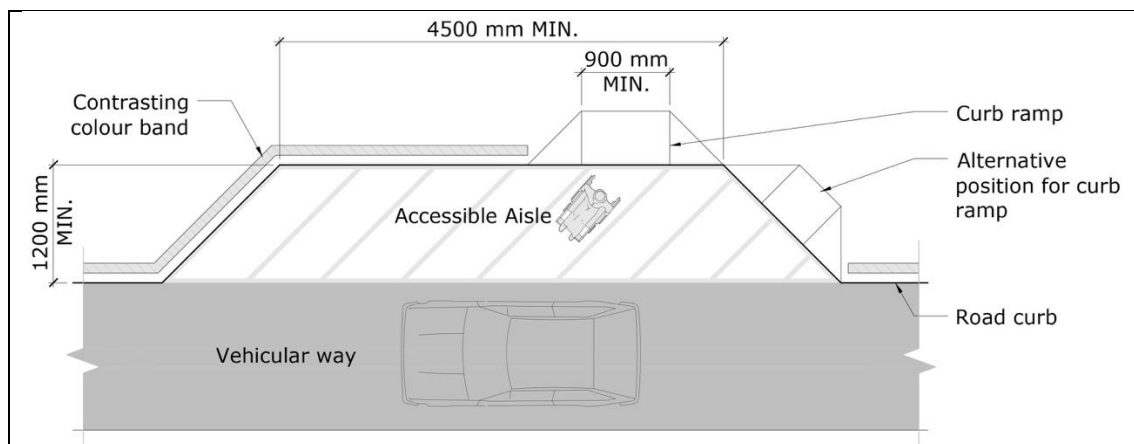


## 14 Parking

### 14.1 Pick-up/Drop-off areas

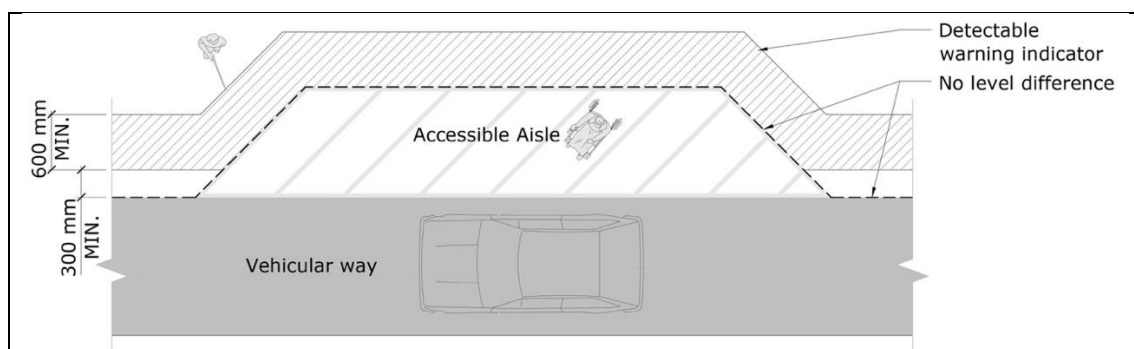
Pick-up and drop-off areas for taxis and private cars shall be linked to an accessible route and provide level surface or kerb ramps.

The next figures present two types of pick-up areas, with a kerb ramp and with no level difference. Depending on the building's design any of them can be used, provided the edge between the sidewalk and roadway is properly marked, with colour contrast and detectable warning indicators as shown in the figures below.



**Figure 15. Pick-up area with kerb ramp**

Layout with two alternative locations for the kerb ramps. This layout should be used when there is no possibility of providing a level drop-of area.



**Figure 16. Pick-up area with no level difference**

Layout with no level difference, the edge between the roadway and the sidewalk is marked by the colour and texture change using a detectable warning indicator

## 14.2 Accessible parking spaces provision<sup>ii</sup>

A minimum of one accessible designated parking spaces should be provided in every parking area. The number of accessible parking spaces shall follow next table:

Table 2. Accessible parking provision

Parking spaces	Accessible parking spaces
up to 10	1
up to 50	2
up to 100	4
up to 200	6
over 200	6 + one for each 100

## 14.3 Accessible parking spaces

Clear directional signs at the entrance of any parking lot shall be displayed to direct drivers to the location of accessible parking places

Vehicle park entrances shall have a height clearance of at least 2200 mm. If the facility will serve vans with platform lift for wheelchair access, a higher clearance should be considered, with a minimum of 2750 mm.

Accessible parking spaces shall meet the following technical requirements:

- Should be located as near as possible to the principal entrance or entrances.
- The route from the accessible parking space to the main entrance should be less than 50 m
- Shall be connected by an accessible route to the entrance. The accessible route shall not require the users to pass behind vehicles that may be backing out.
- The minimum dimensions for shall be 3800 mm x 5500 mm for angled parking and 3800 mm x 6000 mm for parallel parking. For cases where accessible vans park frequently, the dimensions should be adapted to the vehicle size.

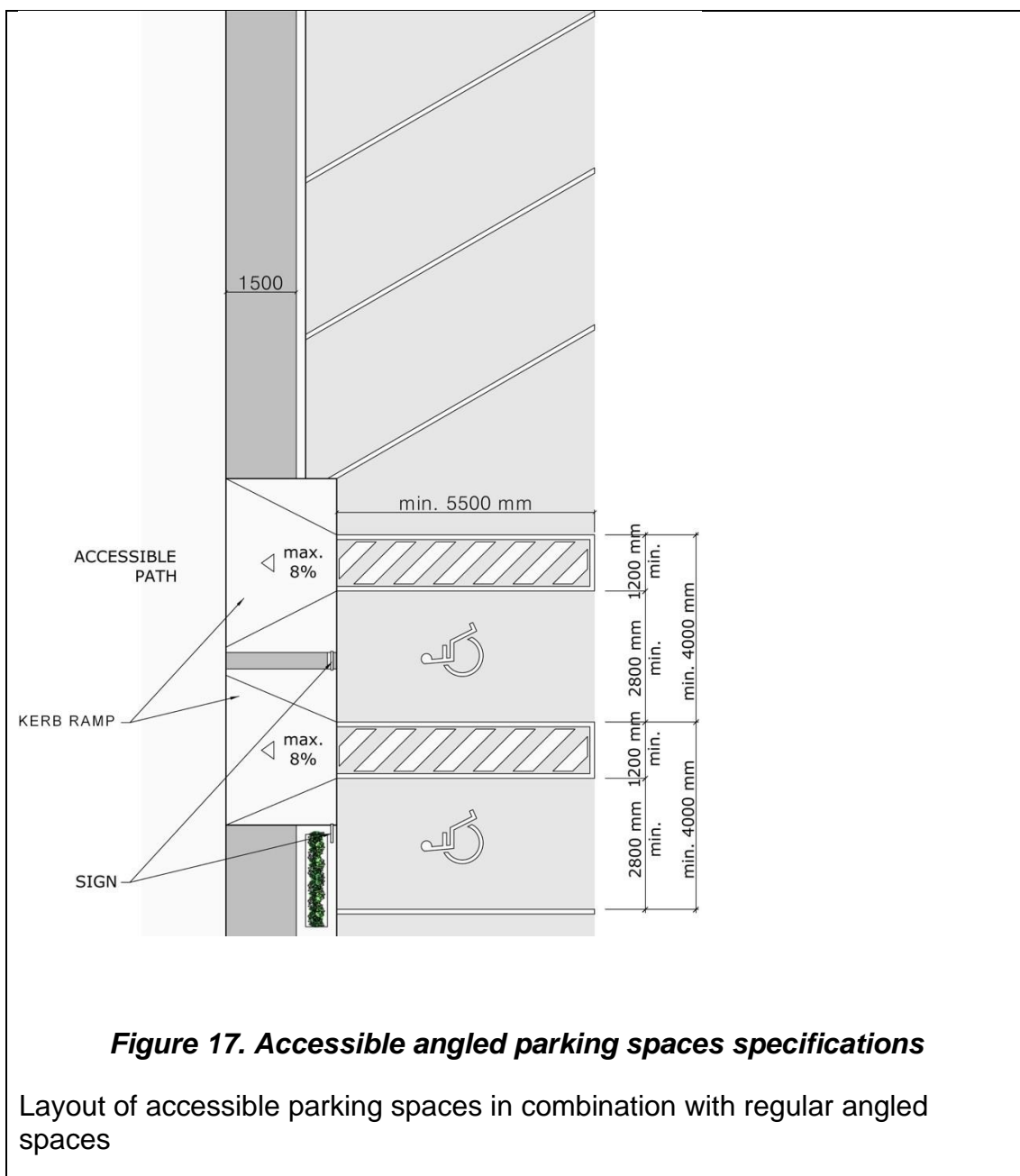


- e) They shall be properly marked with the international symbol of access, painted on the ground and on a signpost. This sign should be easily visible from the driving position and mounted at a height of 2200 mm.

#### 14.4 Auto-pay machines

Shall be located in the same level as the accessible parking space.

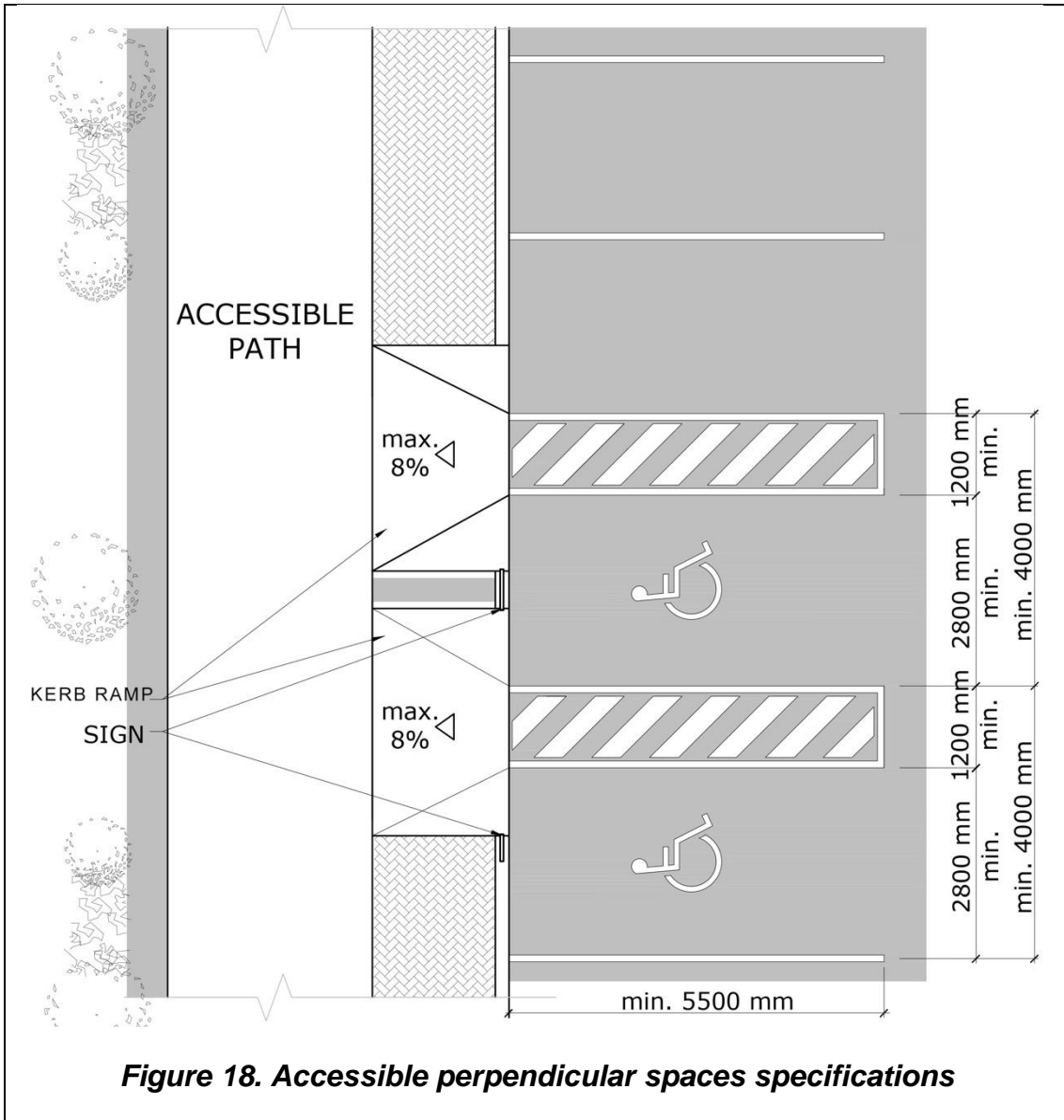
Shall have the operating controls complying with the requirements of this Code, Section 38.



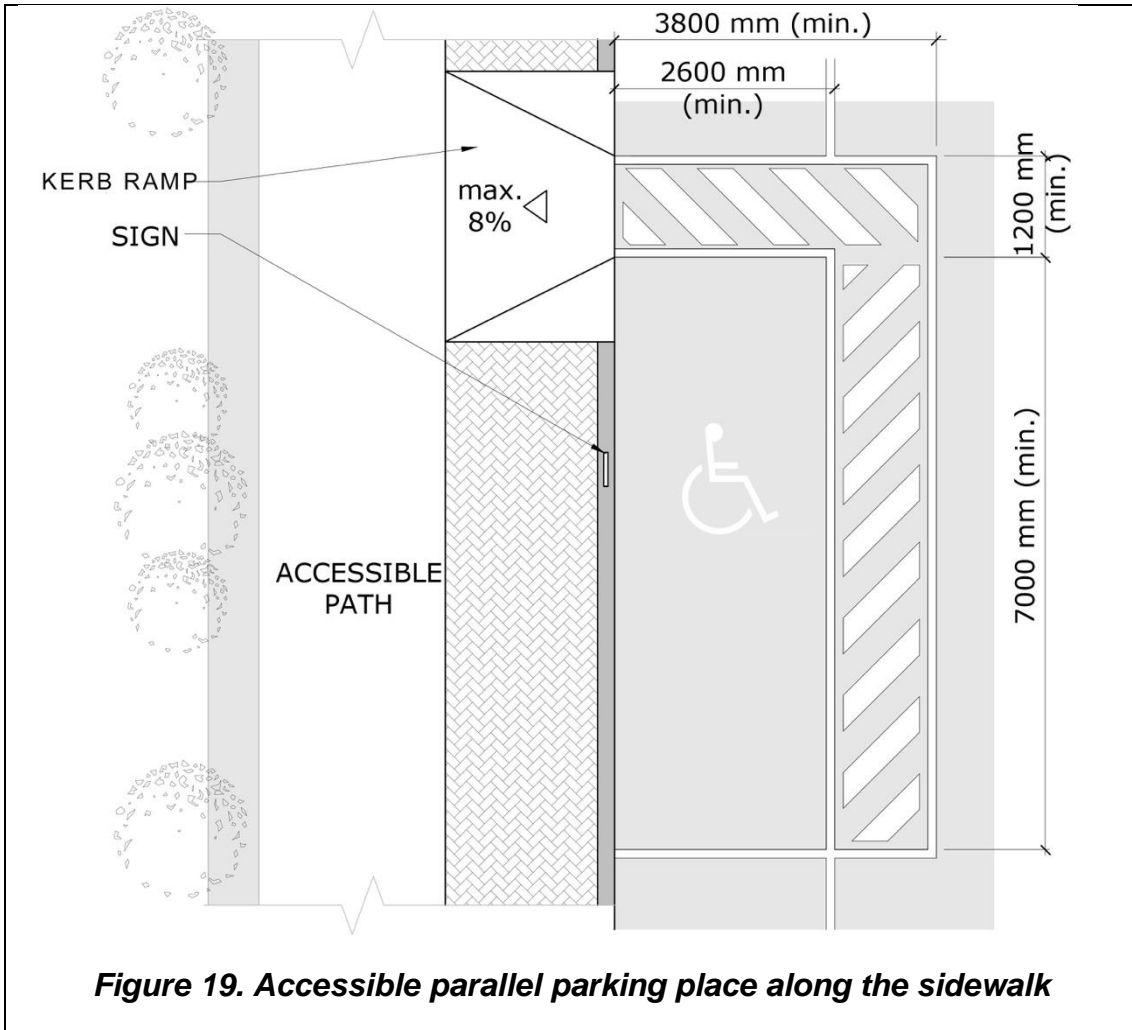
**Figure 17. Accessible angled parking spaces specifications**

Layout of accessible parking spaces in combination with regular angled spaces





**Figure 18. Accessible perpendicular spaces specifications**



**Figure 19. Accessible parallel parking place along the sidewalk**



**Figure 20. Accessible parking sign**

## 15 Buildings entrance

The main entrance to a building shall be identifiable from the boundary of the site and from the designated accessible parking spaces. The entrance should be clearly identifiable from the rest of the building.

Entrances to buildings shall be located and oriented in such a way to ensure the shortest distance for pedestrians between the building and drop-off areas, parking, sidewalk, public transportation stops or other buildings.

An accessible route shall link the parking area, designated accessible parking spaces and the sidewalk to the main entrances of all buildings or facilities.

The accessible route from the street or public space shall avoid stairs and ramps. Gradients up to 5% are acceptable to reach the main entrance(s) at street level. If the gradient is over 5%, it should be designed as a ramp.

The accessible route shall be marked with clear signage, according to the specifications of the Wayfinding section of this Code.

In new buildings, the main entrance or entrances shall be fully accessible to all.

In existing buildings, when the accessible door is not the main entrance door, the direction to the accessible entrance shall be marked with the International Symbol of Access (ISA), as specified in Section 42.10

Each building entrance shall be provided with an identification number that shows the exact address.

A directory shall display the main departments and/or services provided in the building.

An information desk visible from and near the entrance shall be provided in all public use buildings.

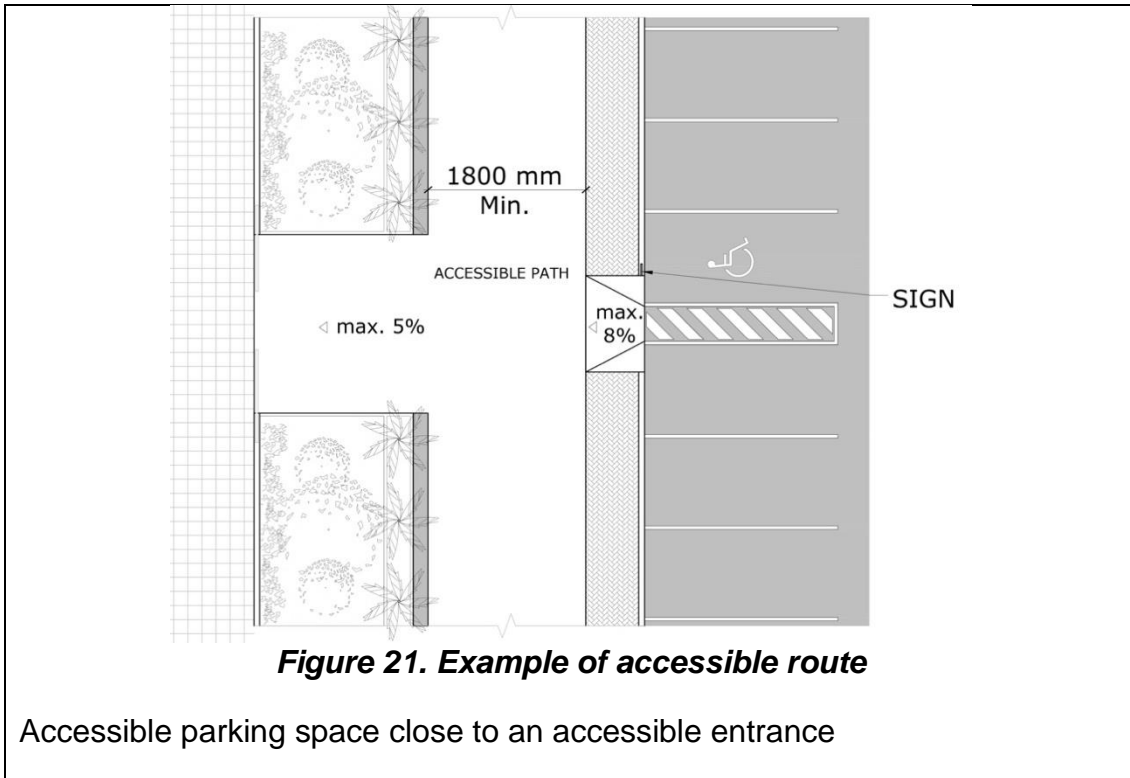
All entrance doors must have a clear passage width adequate to the intended use of the building and the expected number of users. Minimum dimensions are 900 mm width x 2100 mm height.

In case of revolving doors, an alternative door shall be provided,

Entrance doors shall be power assisted, according to the specification of the Doors Section of this Code.

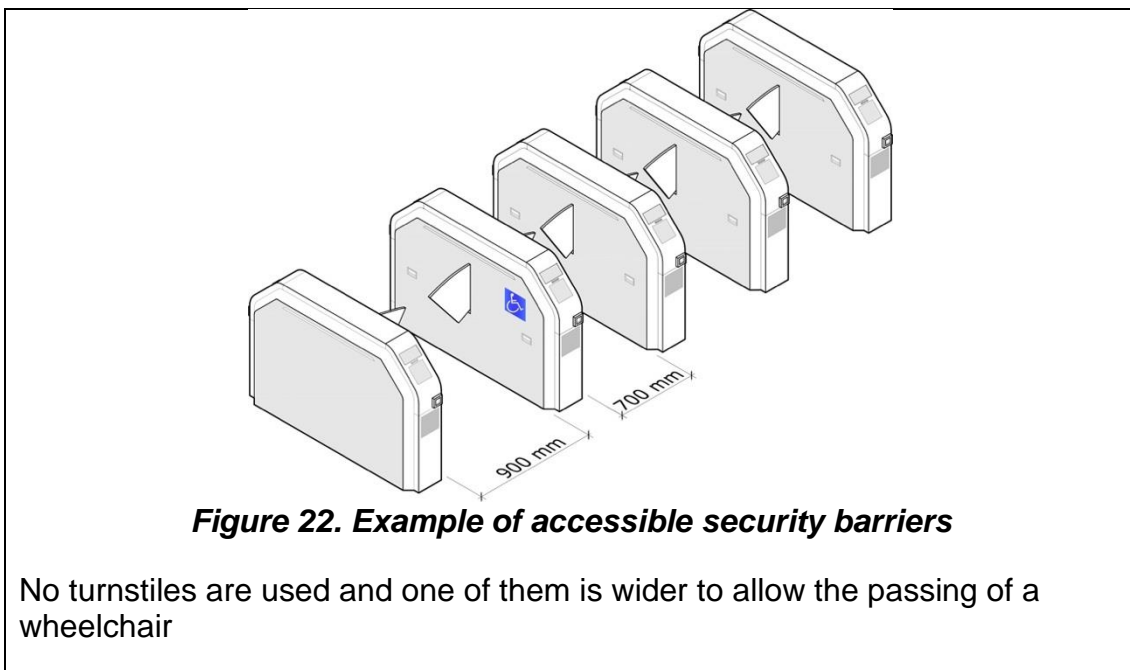
Accessible entrances shall have a flush threshold.

Doormats shall be levelled with the floor with a tolerance of  $\pm 2$  mm.



### 15.1 Security barriers

When applicable, security barriers shall provide at least one entrance with a width of 900 mm. Use of turnstiles is not allowed.



## 15.2 Security access systems

Where security access systems are installed, they shall:

- a) Be located along the accessible route.
- b) Comply with the Controls and operating mechanism section of this code.
- c) Provide equitable alternative means to allow persons with disabilities through the security system, e.g., proximity or contactless scanners or card readers, avoiding the use of biometric systems.

## 15.3 Reception areas

The reception area should:

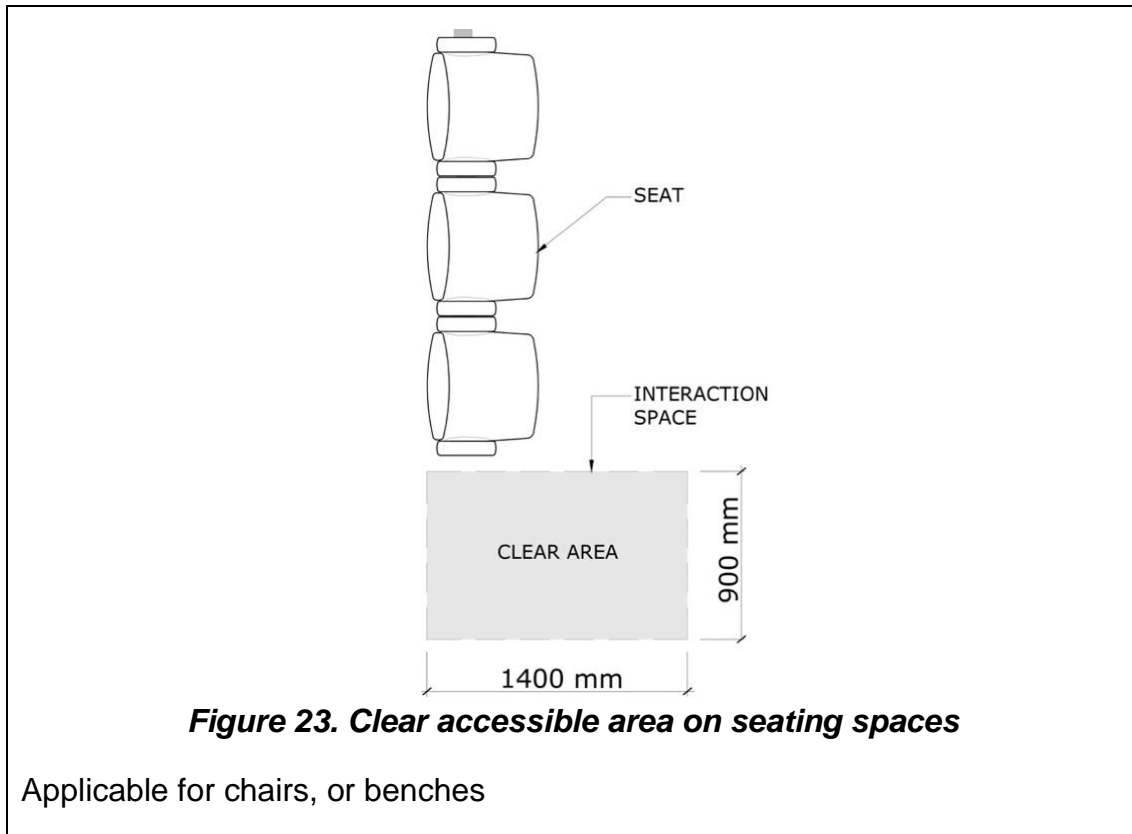
- a) Shall be easily identifiable from the entrance, with a direct route free of any barrier.
- b) The use of queuing lines should allow wheelchair users to manoeuvre to the reception desk. Queuing rails should contrast visually with their surroundings and have a clear width of at least 900mm.
- c) Reception desk when used shall be clearly identifiable and with dual-height counters on both sides, with a lower counter between 750 mm and 790 mm, and a high counter between 950 mm and 1250 mm, allowing its use by a wheelchair user or people sitting down on a standard chair on either side.
- d) A space 680 mm height and 480 mm deep shall be provided under the desk, with a frontal clear approaching space of 1400 mm x 900 mm.
- e) The reception desk shall be located in a position where glare or reflections don't obstruct the ability of deaf or hard of hearing visitors to lip read, e.g. by the presence of windows, glazed screens or mirrors behind a receptionist

## 15.4 Waiting rooms

Reception areas shall provide waiting rooms with the following characteristics:

- a) Access to waiting areas should be direct and unobstructed.
- b) There shall be enough space to accommodate seating places and clear spaces to accommodate wheelchairs, scooters or strollers.
- c) Seating layouts should allow the option of two wheelchair users sitting next to each other, or a wheelchair user sitting next to a user of standard seating.

- d) A mixture of seating options shall be provided, e.g. fixed or removable, with or without arms.
- e) When providing sofas, additional regular chairs shall be provided with a seat height of 430 mm with +/- 30 mm tolerance and armrests.



### 15.5 Electronic queuing systems

If electronic queuing systems are provided, they should provide audio and visual announcements.

## 16 Horizontal circulations

Buildings should be designed, constructed and managed so that the internal layout is accessible and easily understood. All aspects of horizontal circulation, including corridors, should be designed to facilitate ease of movement of all people.

Corridors shall:

- a) Be level and firm.
- b) Should have detectable delimitations and different visual contrast from the surroundings.
- c) Where width of accessible routes or corridors are less than 2000 mm, shall have passing places, 2000 wide and at least 2000 mm in length at reasonable intervals, no more than 50 m apart.
- d) Within office work areas, the minimum width for accessible routes shall be 900mm.
- e) Where there are direction changes (180° and 90°), the clear passage width shall allow a manoeuvring turning space of 1500 mm diameter.
- f) Floor surfaces shall be firm, smooth, stable, and level, without glare and slip-resistant, avoiding vibration in wheels produced by excessive joints. Rugs and carpets should be firmly fixed to the floor and not have a high pile.
- g) Floor patterning that could be mistaken for steps, e.g. stripes, should not be used for floors in corridors.
- h) The accessible route shall present reflectance contrast with the pavement not intended for walking of at least 30 points LRV (Light Reflectance Value) and/or by an easily perceptible (by the foot or the cane) texture difference.
- i) A tactile warning surface shall precede any sudden level change.
- j) The average minimum illumination is 100 lux calculated at floor level, with a minimum value of 60 lux.

The width of corridors free of obstacles should be according to the following Table 3.

Table 3. Minimum corridors width

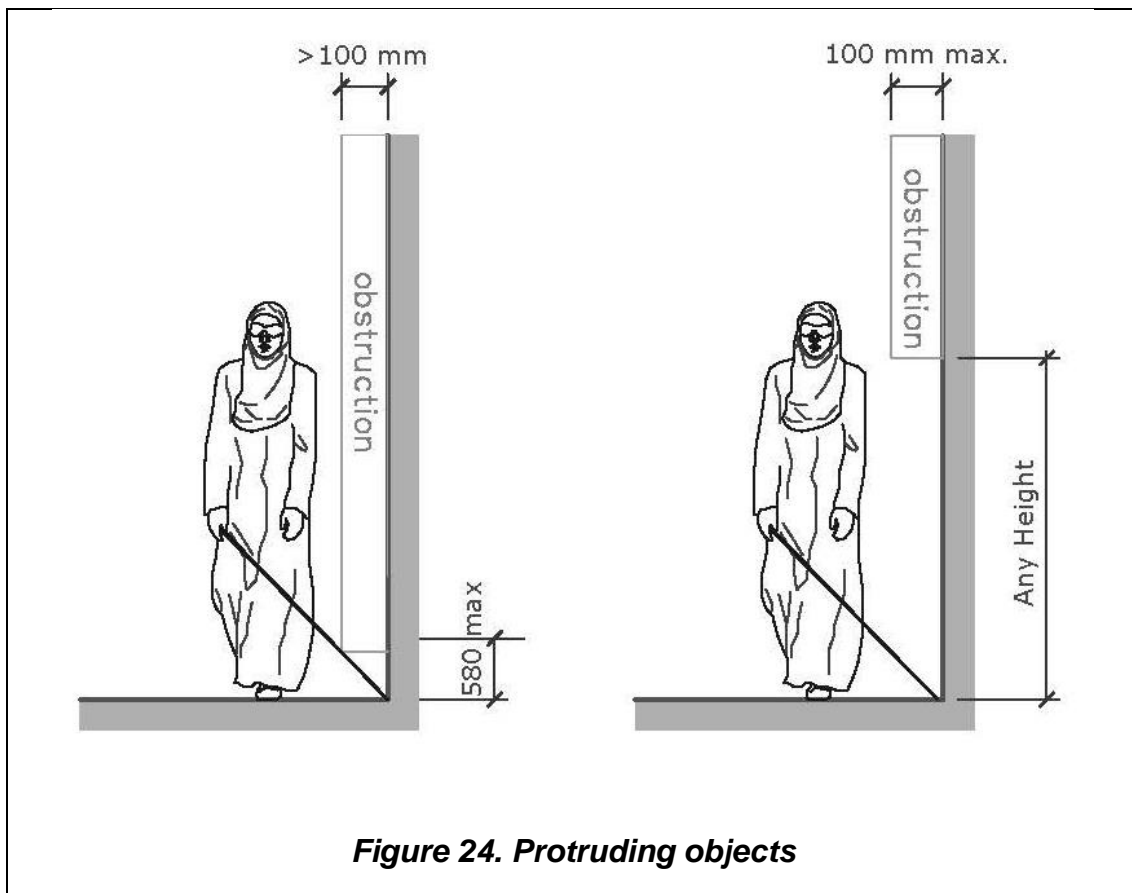
Building Type	Minimum width
Residential developments, hotels, service apartments, workers' dormitories. School, office buildings Factories, workshops, industrial buildings.	2000 mm
Universities, college or similar Parks, open spaces. Sport complex and public swimming pools. Shopping centres and multi-purpose complexes. Markets, restaurants and eating establishments. Hospitals, nursing homes.	2000 mm



## 17 Protruding objects

Objects shall not protrude into the pedestrian path more than 100 mm.

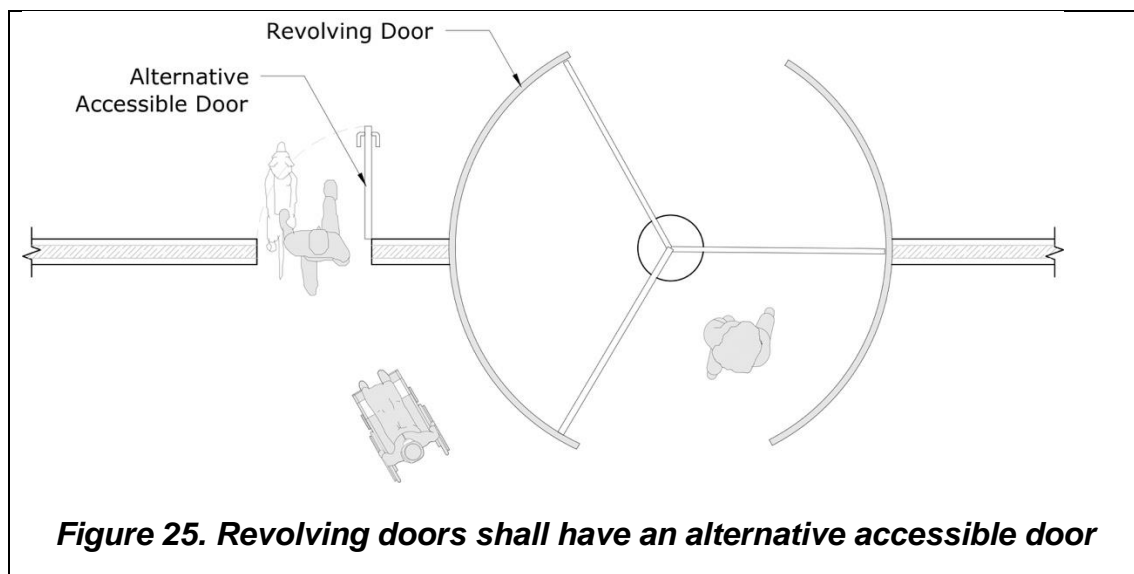
In case of obstructions with their leading edge at any height above 580 mm from the floor shall not protrude more than 100 mm from walls, posts or other elements. Obstructions with their leading edges up to a maximum of 580 mm from the floor level, may protrude more than 100mm, as illustrated in the Figure 24 below, as that height allow them to be detected by a person's white cane.



## 18 Doors

Doors along or connecting to accessible routes must meet the following requirements:

- a) Automatic doors are preferred for public building entrances and high pedestrian traffic areas.
- b) Doors should have a free passage width of minimum 900 mm. This free passage must be measured between the face of the door and the face of the doorstop with the door open at 90°.
- c) Opening and closing mechanisms shall be placed between 900 mm and 1200 mm in height and shall be easy to grasp and use. Pressure mechanisms or levers shall be easy to operate with the elbow or be automatic.
- d) If lever systems are provided, they must be separated from the door body by at least 40 mm.
- e) Thresholds shall flush with surrounding floors. If required, level thresholds no higher than 6mm.
- f) Spring-operated doors shall be avoided
- g) If there is a revolving door, an alternative accessible door shall be provided immediately adjacent to the revolving door.



## 18.1 Door hardware

Round knobs are not allowed.

Handles, pulls, latches and locks shall:

- a) Be operable with one hand.
- b) Not require tight grasping, pinching or twisting of the wrist to operate.
- c) Be mounted at a height of 900 mm to 1100 mm from the floor.
- d) Be colour contrasted with the background.

For sliding doors, a vertical fixed bar shall be provided to open the door.

The opening space of a door shall not invade the manoeuvring spaces and the accessible paths.

The force required to open a door shall be a maximum of 25 N.

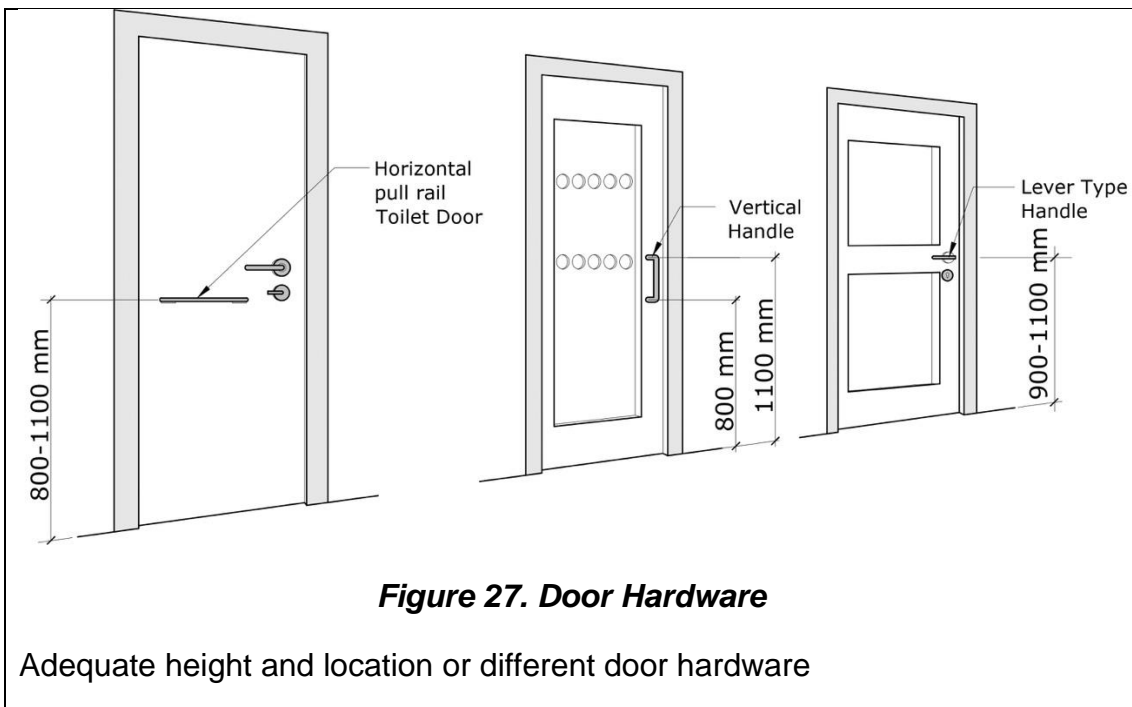
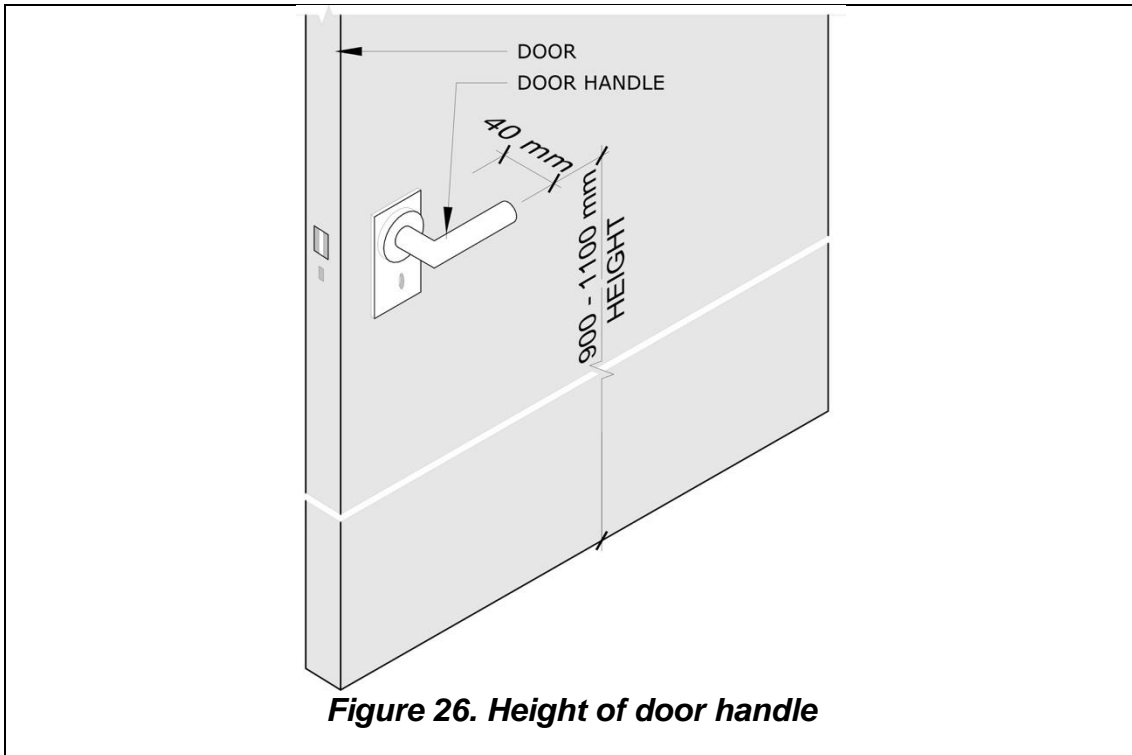
A swinging doors leaf shall be able to open at 90°.

Where a raised threshold is provided, it shall have a maximum height of 15mm, be bevelled when higher than 5 mm and contrast visually with the adjacent floor.

Doorstoppers shall be provided to prevent the door from hitting and damaging the wall.

Where there are two or more door leaves at least one of the leaves of the door must be able to be considered an accessible door according to the above specifications.

Kick plates of at least 250 mm high are recommended in high use areas.



## 18.2 Manoeuvring spaces<sup>iii</sup>

Doors shall have a clear manoeuvring space on both sides.

The dimensions of these spaces shall fulfil the following requirements:

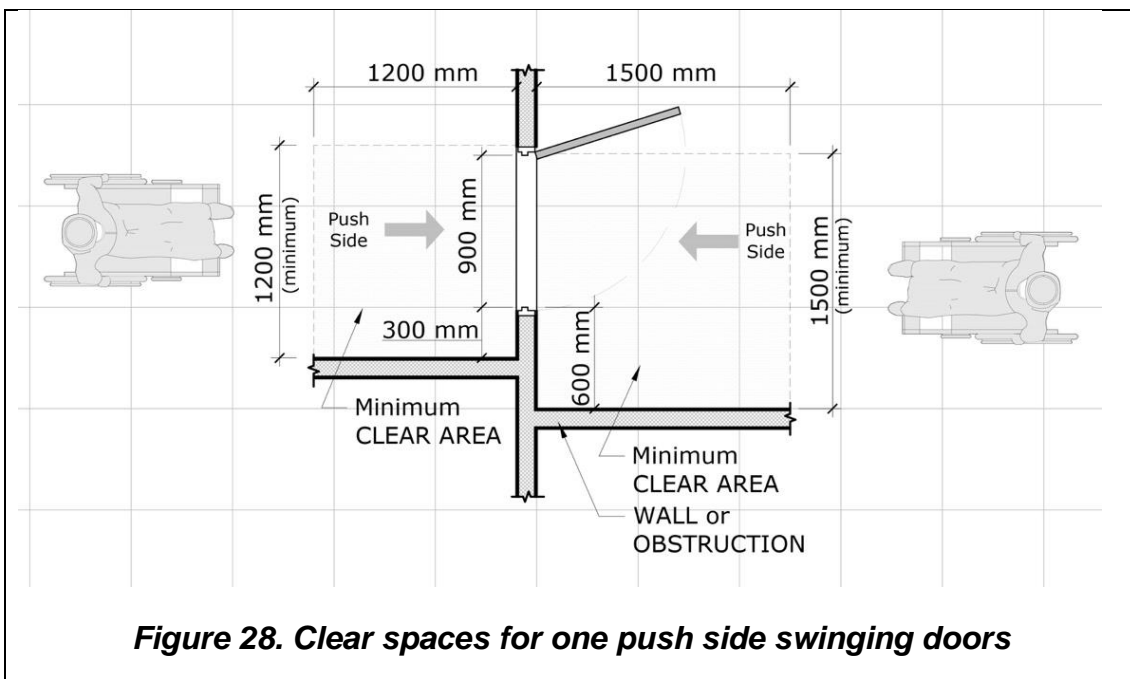
On the pull side, a minimum space of 600 mm adjacent to the leading edge of the door with a minimum clear floor space of 1500 mm x 1500 mm shall be provided.

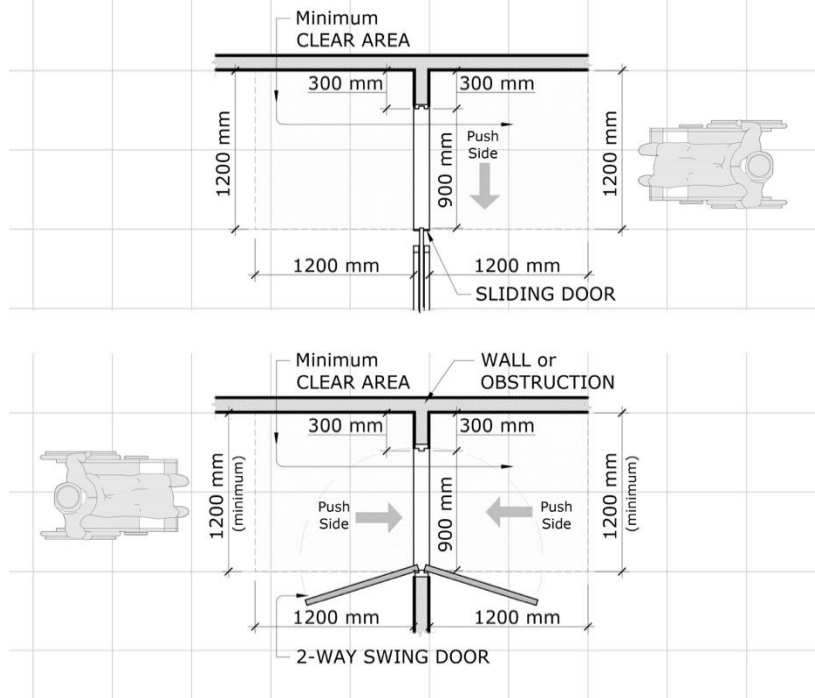
On the push side, a minimum space of 300 mm adjacent to the leading edge of the door with a minimum clear floor space of 1200 mm x 1200 mm shall be provided.

In sliding doors, a minimum space of 300 mm adjacent to the leading edge of the door with a minimum clear floor space of 1200 mm x 1200 mm in both sides shall be provided.

Clear floor space shall not be obstructed by other swinging doors and they shall be free of obstacles.

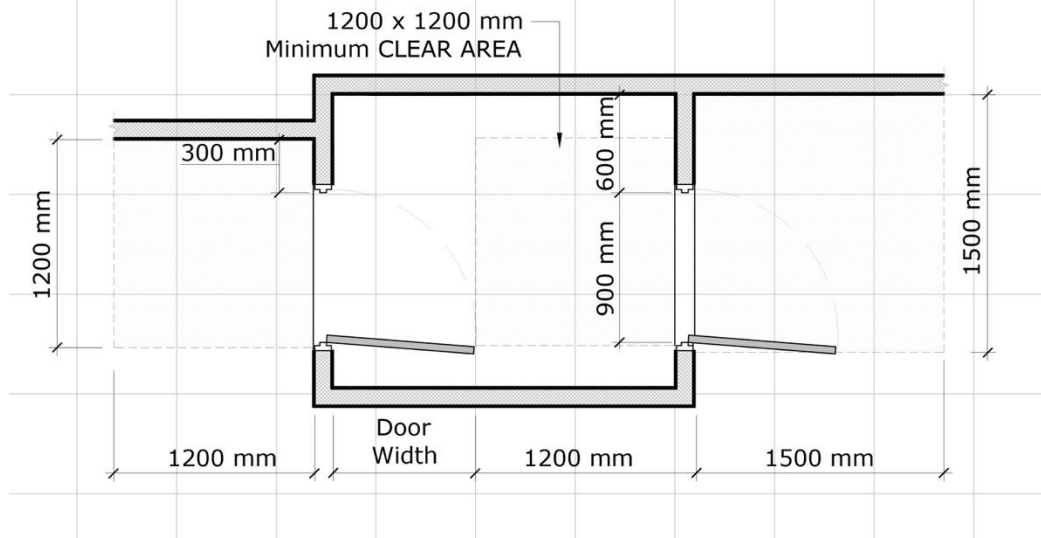
When two doors are installed in a series, they shall have a minimum space of 1200 mm between them plus the width of the door swinging into that space.





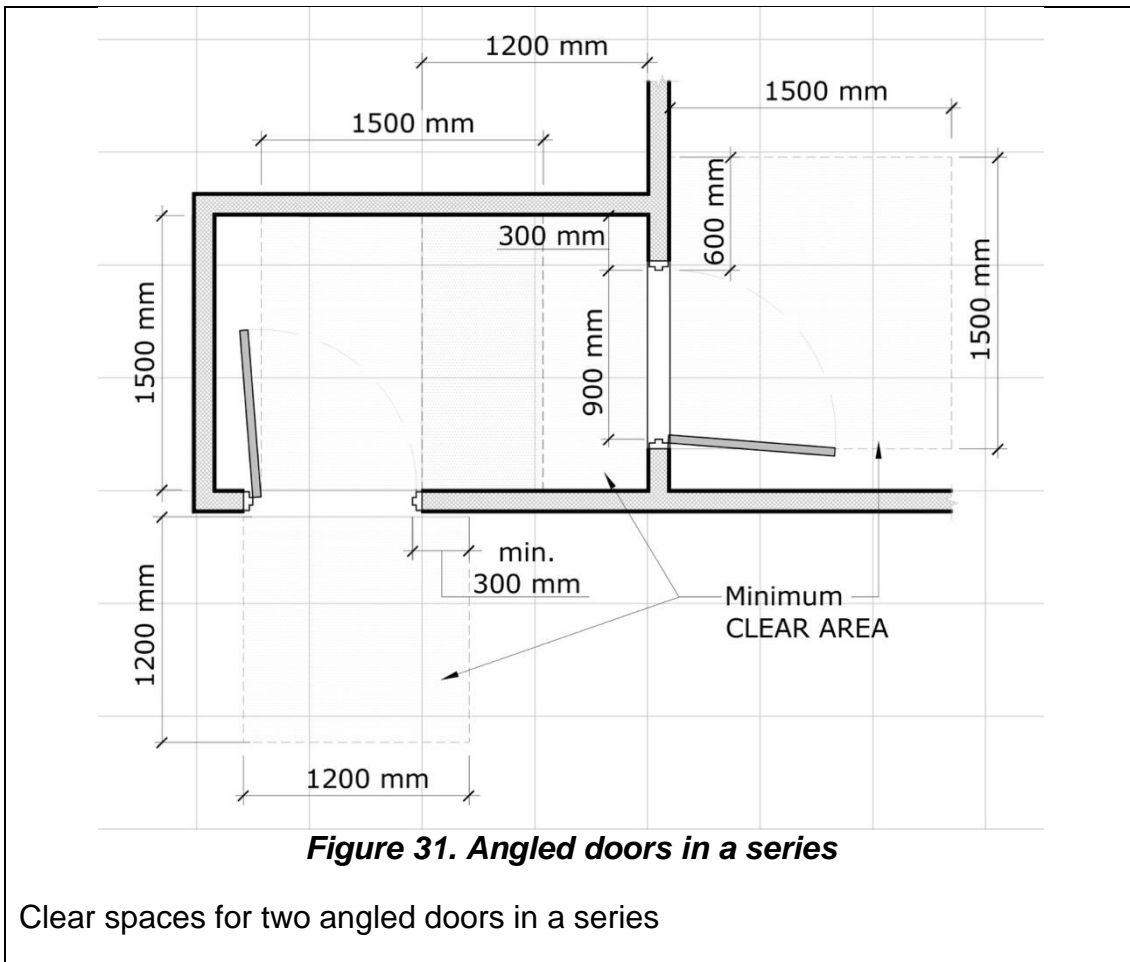
**Figure 29. Door clear spaces**

Clear spaces for both-side push swinging doors and sliding doors



**Figure 30. Door clear spaces**

Clear spaces for two aligned doors in a series



### 18.3 Power-assisted doors

Automatic doors are preferable, for high traffic areas and buildings' main entrances, being sliding doors the most convenient to use as they do not require guardrails for door-swing protection.

Power-assisted doors can be automatically activated using a motion detector, a floor-pad sensor, or be manually activated by pushing a control.

Power-assisted swinging doors shall:

- Take 3 s or more to move from a closed to a fully open position.
- Remain fully open for a minimum of 5 s.
- Require a force of not more than 66 N to stop door movement.

## 19 Glass doors and surfaces

All fixed glass surfaces shall not be confused with doors or openings,

Glass doors or panels that do not have elements that can be identified, such as frames or handles, shall contain visual elements that guarantee its detection.

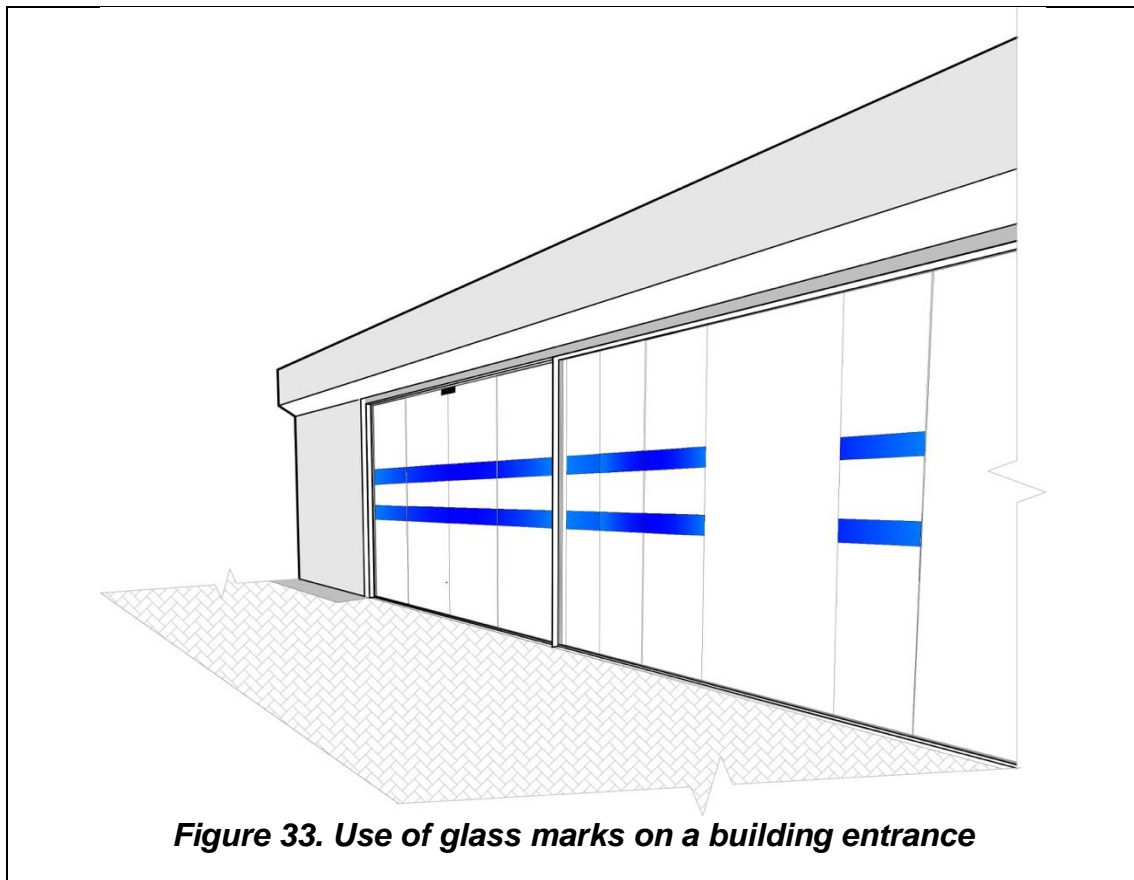
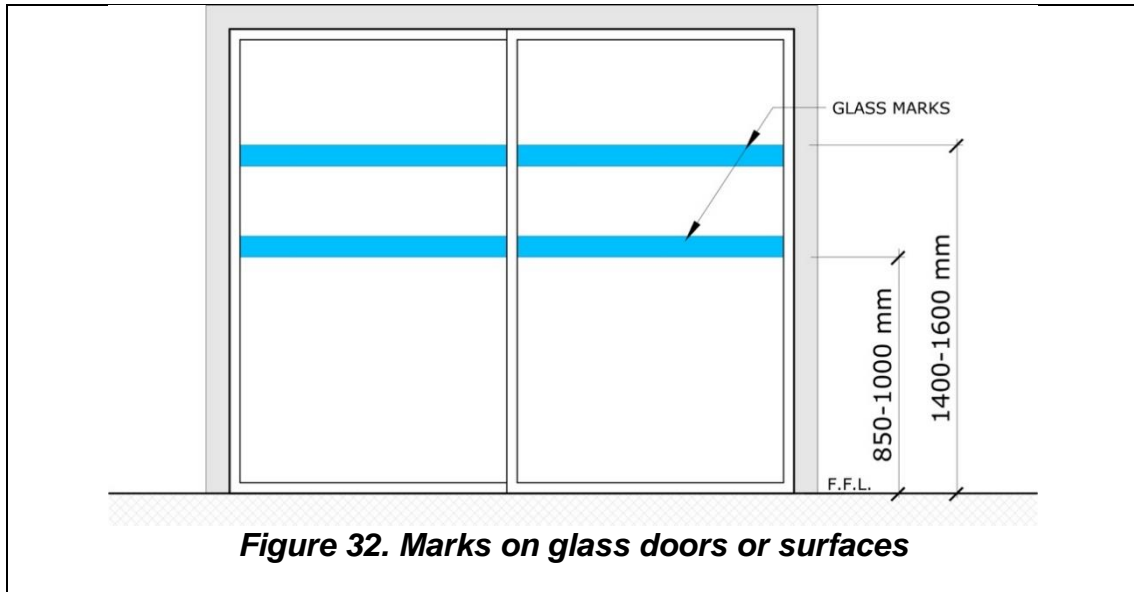
The marks shall consist of two horizontal bands, each at least 100 mm high, and shall have a reflectance contrast with the glass background of at least 30 points LRV (Light Reflectance Value).

The upper band shall be affixed at a height between 1400 mm and 1600 mm and the lower band affixed at a height between 850 mm and 1000 mm above the floor.

It is not necessary to mark the glass surfaces with contrasted bands in the following cases:

- a) In glass surfaces of less than 500 mm in width.
- b) The highest point of the glass surface is less than 850 mm.
- c) If it has other opaque elements between 850 mm and 1700 mm occupying its entire width.
- d) If it has other types of marks (logo, artistic illustrations, etc.) that occupy 50% of the area between 850 mm and 1700 mm without empty spaces bigger than 500 mm wide.
- e) Glass surfaces with fixed elements in front of it that block the entire approaching space.

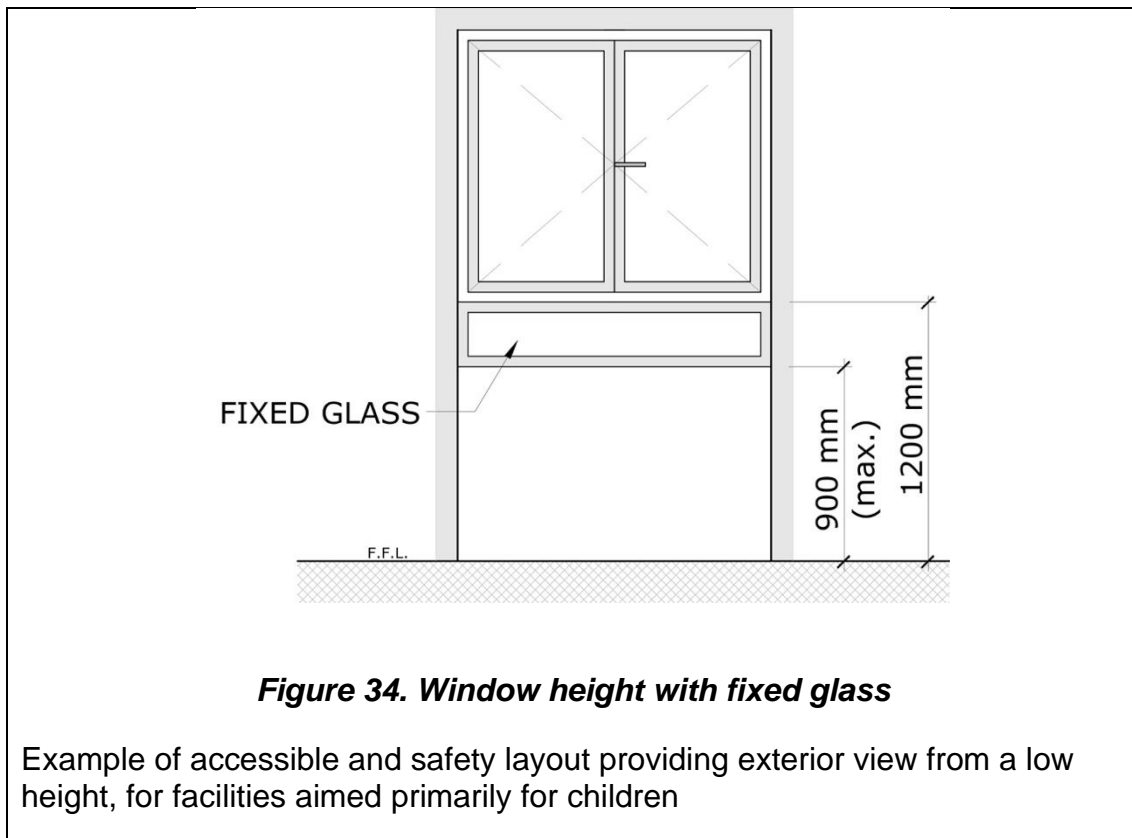




## 20 Window and window hardware

Windows and window hardware shall fulfil the following requirements:

- Windows should not open outwards into circulation routes below a height of 2100 mm.
- Pressure mechanisms or levers are preferred and shall not require wrist turning or pinching, and should be easy to operate with a single hand, or be automatically operated.
- The glazing should start no higher than 900 mm from the floor in order to provide exterior vision to children, people with short stature and wheelchair users if they will be regular users of a room or building. Guardrail protection shall be provided if windows can be opened lower than 1200 mm.
- Window controls and hardware shall be positioned between 800mm – 1000mm above floor level.
- Figure 34 shows a window layout with a fixed panel between 900 and 1200 as a security measure for children, but still allowing viewable area.



## 21 Handrails and grab bars

### 21.1 Handrails

Handrails provide support, stability and guidance to users, especially during a fire evacuation. Handrails must be designed to be easy to grasp and to provide firm and comfortable grip, allowing the hand to slide along the rail without any obstruction.

Handrails used in stair, ramps or any other level change must meet the following requirements:

Stairs and ramps with a change in level greater than 500 mm must have continuous handrails on both sides with a 300 mm horizontal extension at its ends. Figures 35, 36, 37, 38 and 39 show the characteristics of accessible handrails for ramps and stairs, including its use in combination with guardrails (Fig. 35).

When the stair widths are greater than 2700 mm an additional intermediate handrail should be installed. The width between intermediate handrails should be at most 1500 mm.

In ramps, the distance between the handrails shall be 1000 mm.

Handrails should be continuous throughout the flight of a ramp, stair, stepped path and intermediate landing, except where they intercept with a doorway or path of travel.

The handrail should be mounted at a height of 900 mm. An additional handrail shall be provided at a height between 650 mm and 750 mm.

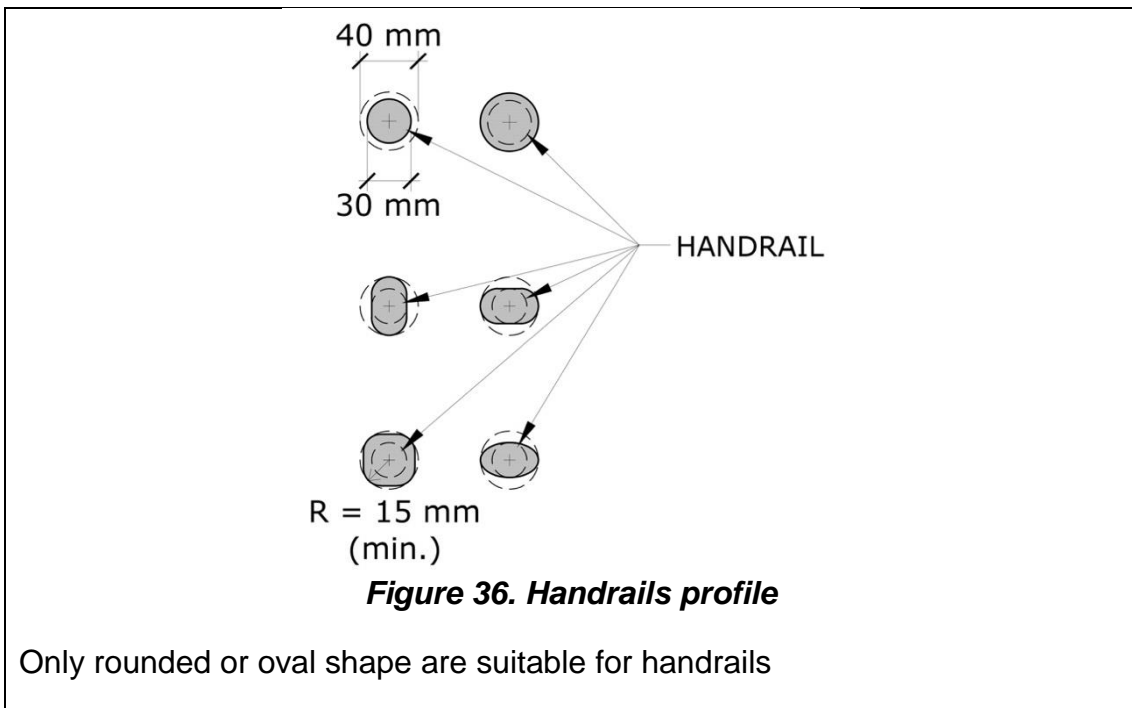
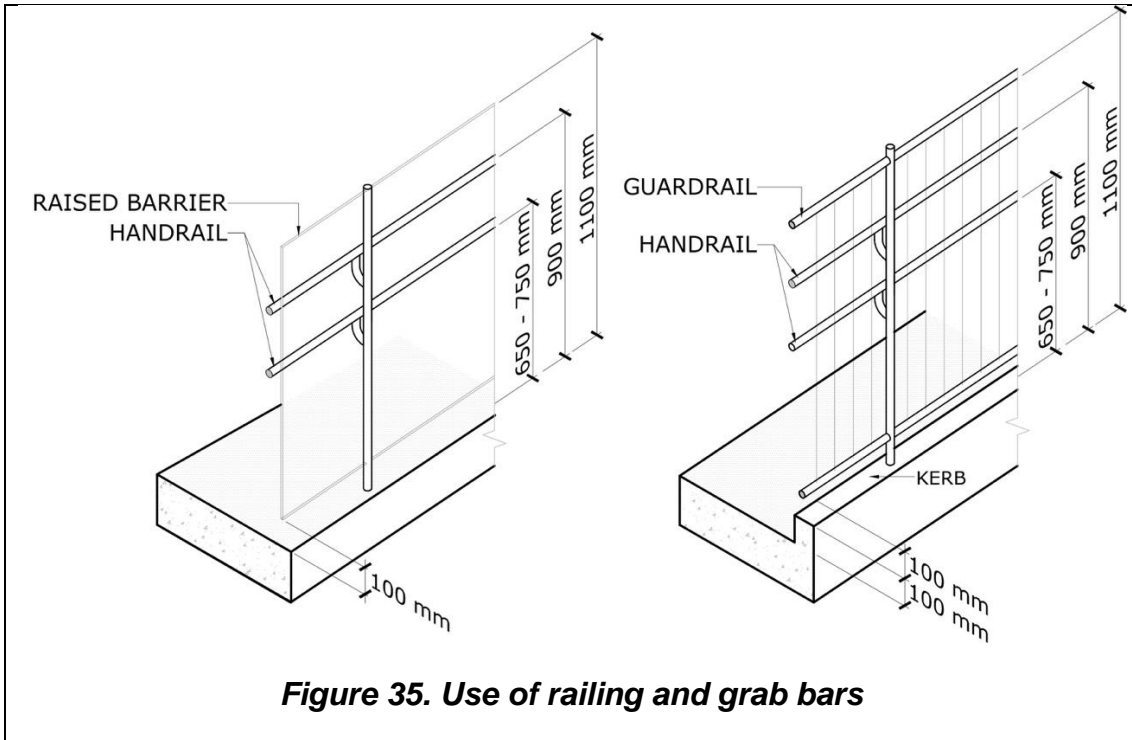
The handrails must be safely secured and installed to resist a force of at least 1.3 kN applied vertically or horizontally.

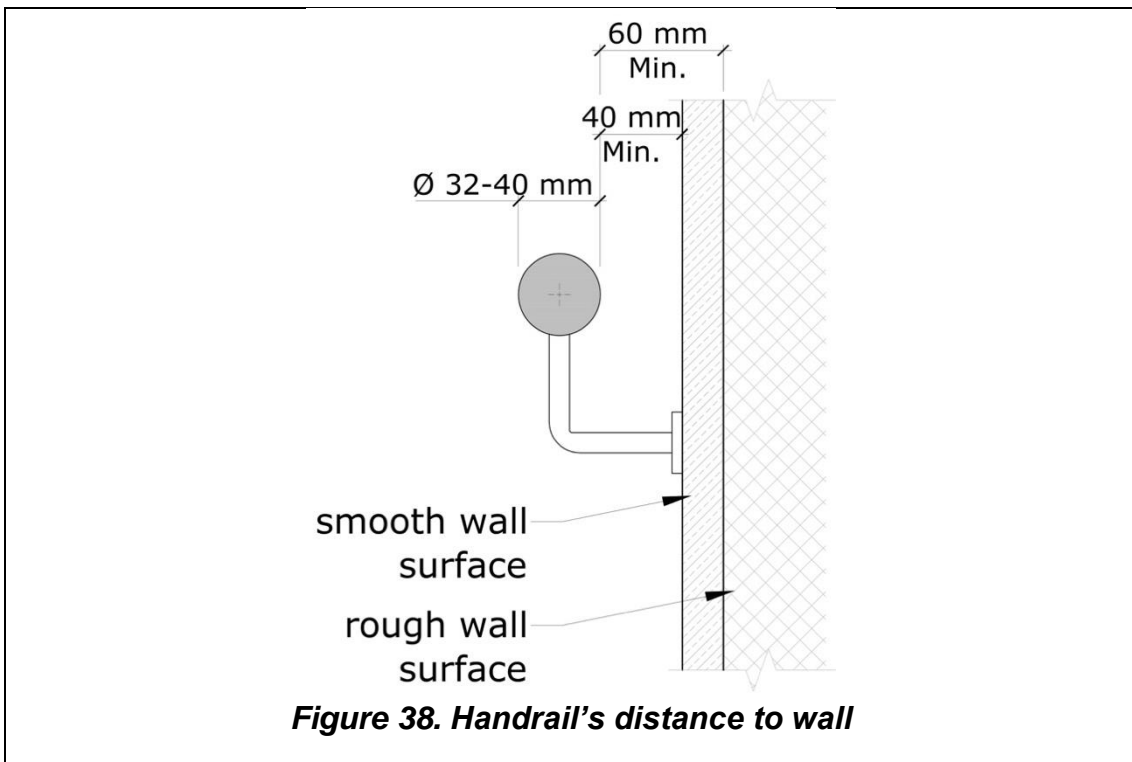
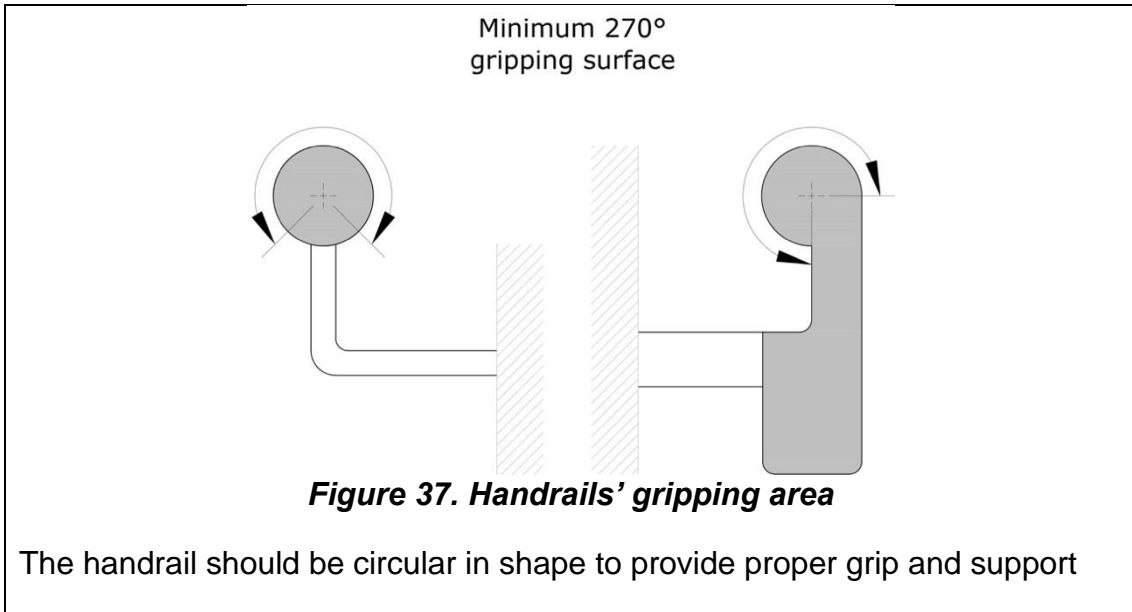
Handrails must have an anatomical design that allows adjustment to the hand with a circular section of 32 mm to 40 mm diameter or an equivalent gripping surface. Handrails must be separated from the wall surface at least 40 mm. The handrail section and its mounting system should not interfere with the continuous gripping surface.

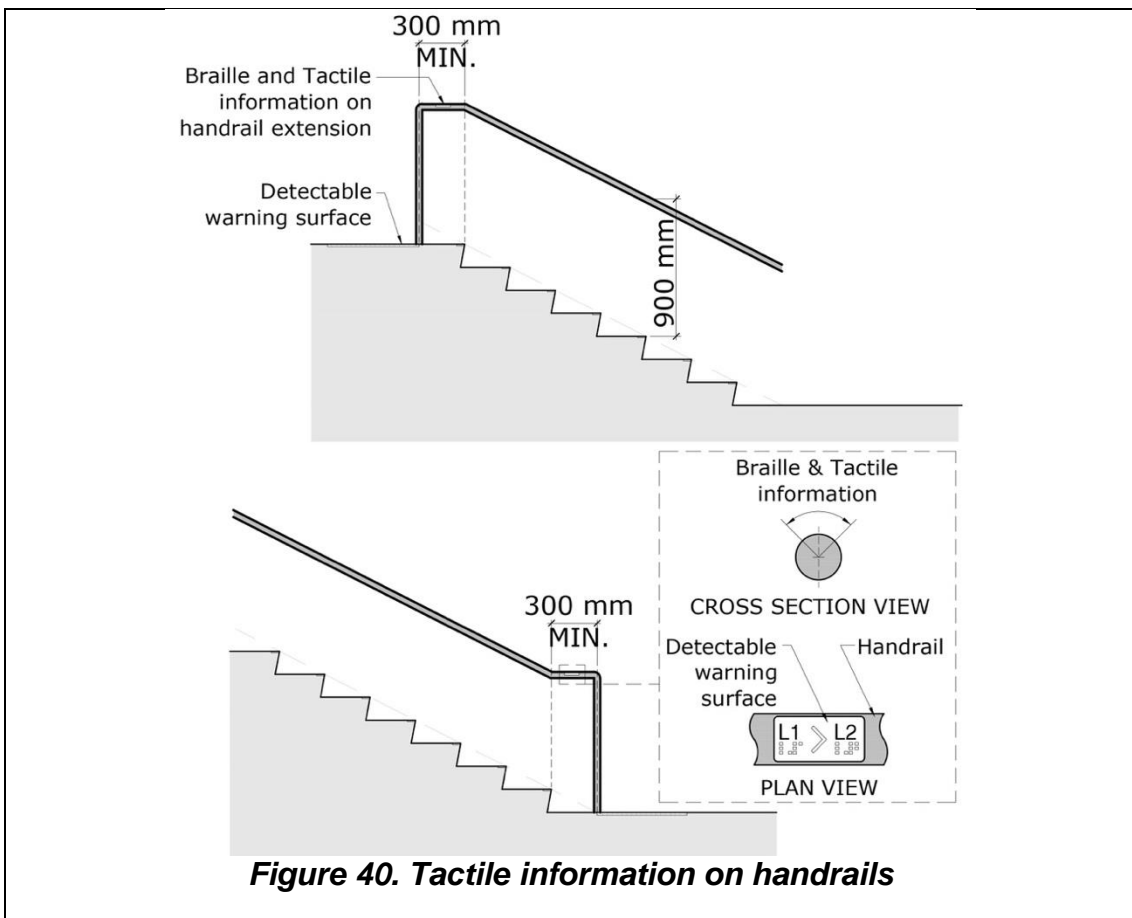
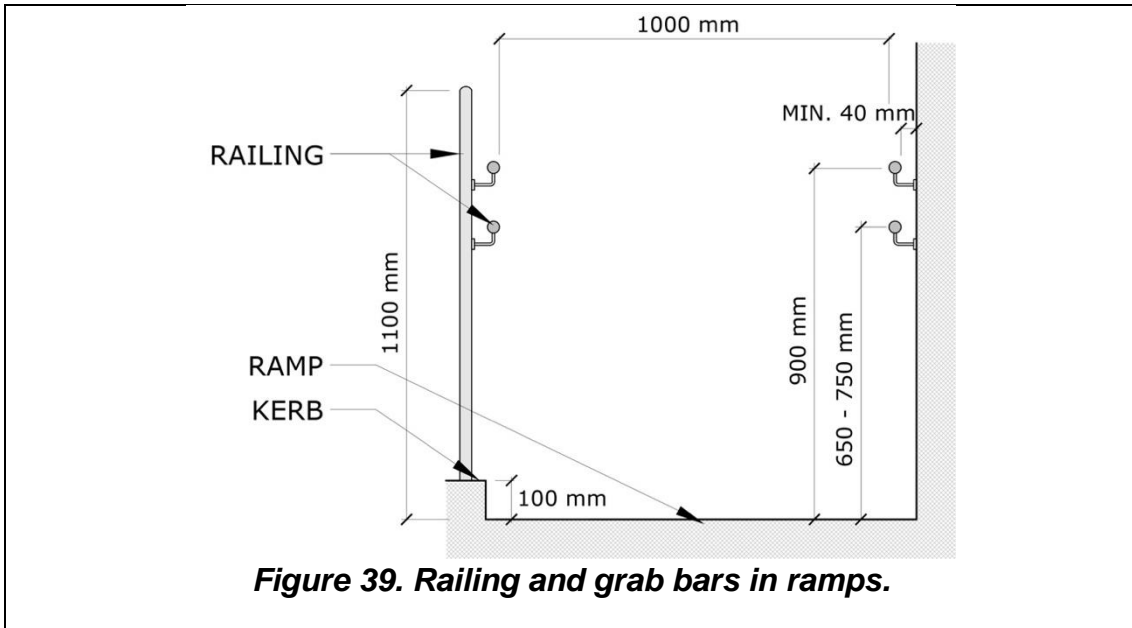
Handrails must have a contrasted reflectance of at least 30 points LRV against its background.

Handrails can have raised text or tactile symbols unobtrusively and permanently fixed as an important source of information or people with visual impairments, e.g. indication of floor number, location of fire exits, etc., as shown in Figure 40.

All handrail materials exposed to intense sun radiation shall prevent reaching high temperatures that may damage the users.







## 21.2 Grab bars

Grab bars shall:

- a) Be slip-resistant
- b) Have a diameter between 32 and 40 mm
- c) Have a space of 40mm between the grab bar and the wall where mounted

## 22 Tactile surfaces

Tactile pavements are textured surfaces with contrasted colour that are perceptible and identifiable by feel of feet or cane, or residual functional vision that warns or informs people with visual disabilities.

Tactile pavements shall have a reflectance contrast with the surrounding pavement of at least 50 points LRV and the height of this pavement above the finished floor level cannot be greater than 4 mm.

People who are blind or have visual impairments need a tactile element for helping in their orientation across large outdoor areas. Tactile surfaces shall be used to indicate the accessible route, especially where no other clues indicate the route to, from, around or inside a building; where there is a situation that may represent a hazard to persons with vision impairment, or that is not highlighted by any other feature.

Tactile pavements must be installed according to the following criteria for:

- a) Detectable warning surfaces
- b) Tactile guiding surfaces

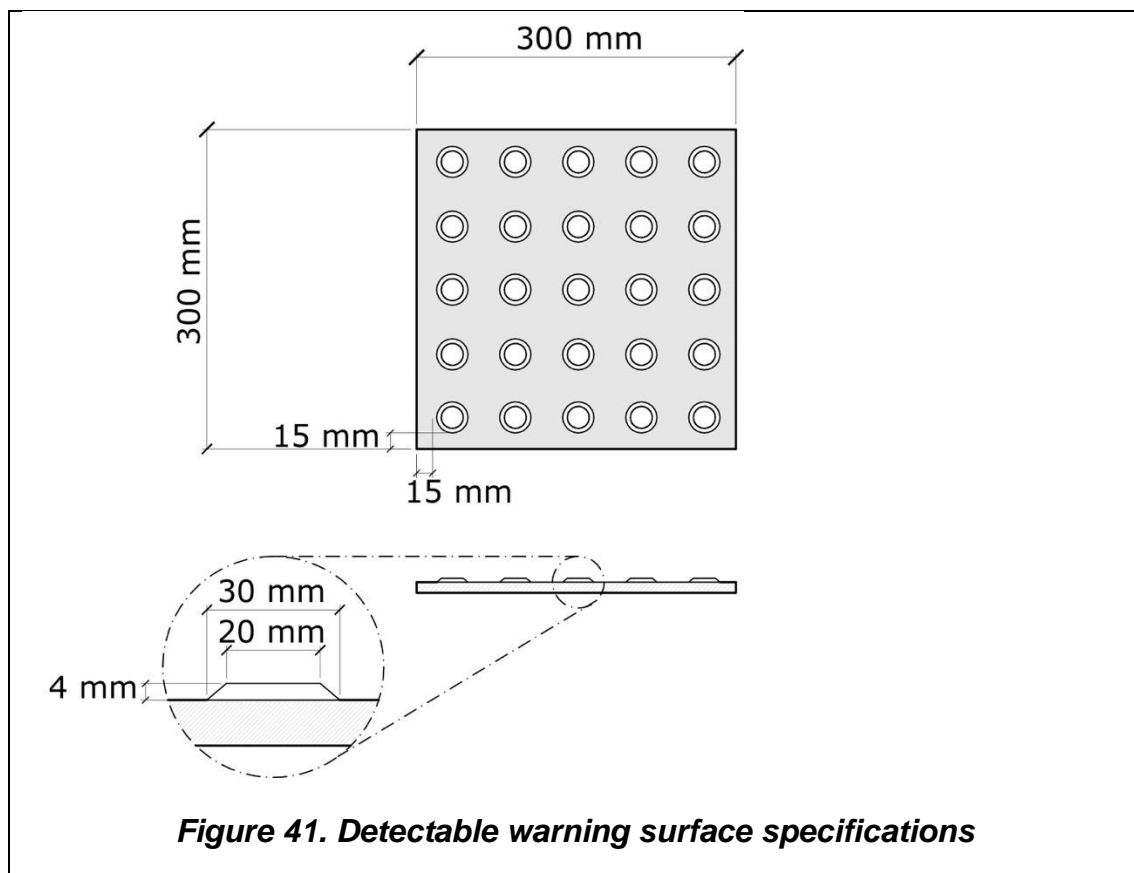


## 22.1 Detectable warning surfaces

Detectable warning surface are used as a warning for upcoming level changes or obstacles on the path of travel. Warning pavement shall be constructed of truncated cones arranged in a square grid or diagonal rows and installed with bands oriented in the crosswise direction of the path of travel. It must be installed along the entire width of the element and not less than 300 mm from the beginning of the dangerous element. The warning surface shall have a width between 300 mm and 400m.

The most common elements where warnings are required include:

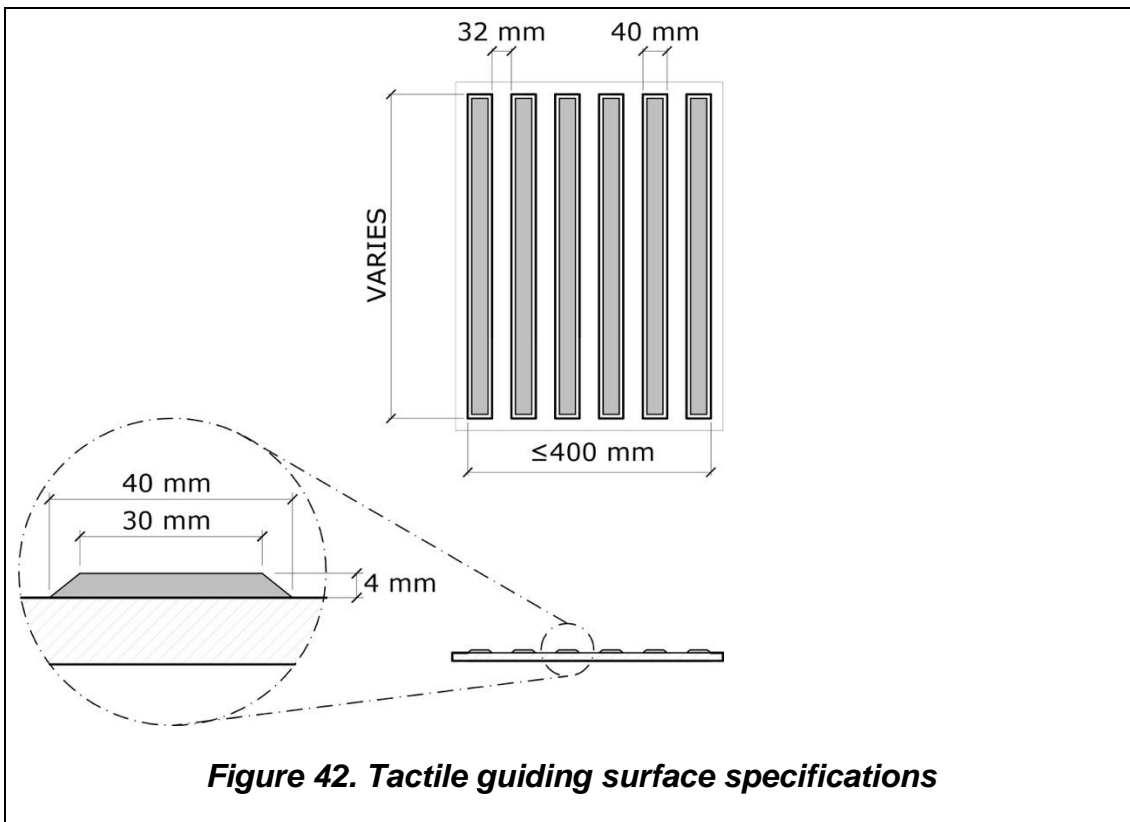
- stairs,
- ramps,
- rail and port platform borders,
- unprotected changes in level,
- pedestrian crossings
- to indicate the end of a tactile guiding surfaces

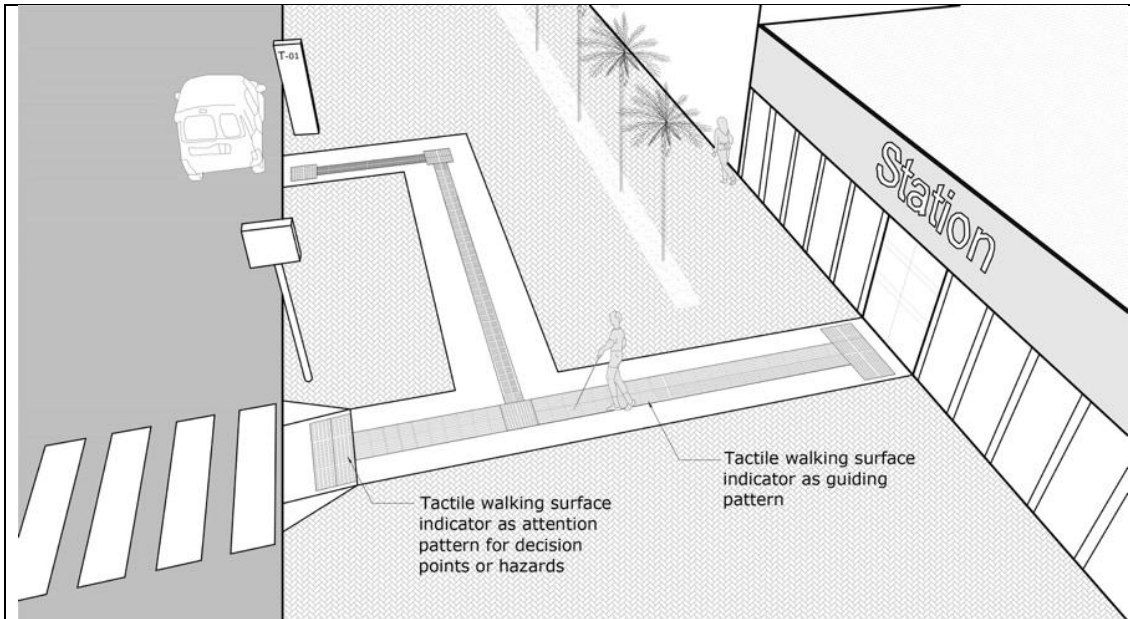


## 22.2 Tactile guiding surfaces<sup>iv</sup>

Tactile guiding surfaces are elements used as a directional sign to assist the independent mobility of people with visual disabilities. Guiding patterns should be constructed of flat-topped elongated bars. Bars must be oriented in the direction of the course of travel.

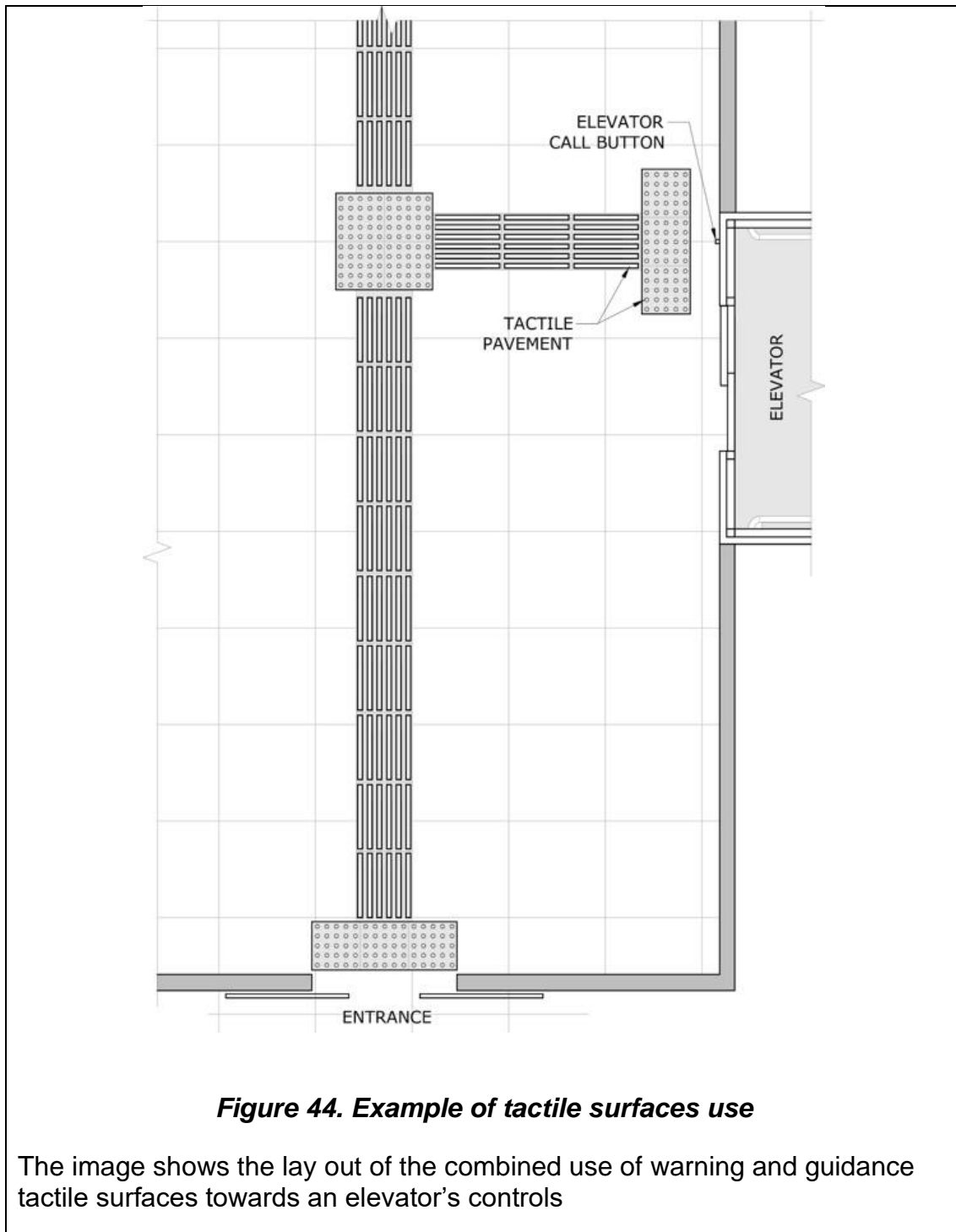
The tactile guiding surface shall have a minimum width of 400 mm. The distance among longitudinal stripes can't exceed 32 mm.





**Figure 43. Example of tactile surfaces use**

The image shows the lay out of the combined use of warning and guidance tactile surfaces towards a building's entrance



**Figure 44. Example of tactile surfaces use**

The image shows the lay out of the combined use of warning and guidance tactile surfaces towards an elevator's controls

## 23 Vertical circulations

### 23.1 Elevators

A conventional accessible passenger elevator should be provided in every new public building with more than one floor.

Accessible elevators in new public buildings must be accessible from the ground floor and reach all levels intended for use by the building occupants, including any below ground level.

In existing buildings, where the installation of such elevator might not be possible, an enclosed vertical lifting platform should be provided, for maximum allowed travel heights as indicated in Section 23.4

Signs indicating the location of accessible elevators should be provided and be visible from the building entrance and in each floor.

The requirements to be fulfilled by an accessible elevator are:

- a) The dimensions should be appropriate for the intended number of users and in all instances, equal to or bigger than the hereby specified minimum dimensions of the cabin.
- b) The minimum internal car dimension shall be no less 1200mm by 1400 mm. However, considering the current use of motor wheelchairs and scooter, the recommended minimum dimensions shall be 1500 mm by 1500 mm.
- c) If a facility has various options of vertical circulation there shall be a sign indicating the location of the accessible elevator.

### 23.2 Elevator's doors and lobby specifications

The elevator doors for each floor and the car must be:

- automatic operation,
- have a minimum width of 900 mm,
- minimum height of 2100 mm,
- and present colour contrast against the surrounding walls.

Doors shall open automatically and shall remain opened at least 3 seconds.

There should be a minimum clear manoeuvring space of 1500 mm x 1500 mm in front of the elevator access door and in front of the hall's call buttons.

Elevators' call buttons shall be located at a height between 900 mm and 1200 mm.

Floor indicators shall be located at a height of maximum 1800 mm.

There should be an audible announcement of lift arrival and direction of travel.

A sign indicating the number of the floor should be provided in each elevator lobby on the wall opposite to the elevator landing doors.

### **23.3 Elevator car features**

Handrails shall be placed in at least to interior walls, at a height of 900 mm from the floor, preferably three shall be provided, located on both sides and at the rear of the car.

The floor should be slip-resistant and have similar qualities as the floor of the elevator landing to minimize the risk of slips, trips and falls. The elevator car's floor shall be level with the landing in each floor.

A mirror shall be placed inside the elevator on the wall opposite to the door, from the handrail height upward, covering the full back panel.

Braille and tactile signage shall be provided on the door jamb at a height of 1500 mm, indicating the floor number or name.

Audible signals or an audible voice announcement shall sound when each floor is reached.

Buttons shall be located at a height between 900 mm and 1200 mm. They shall present high-embossed European numerals. Braille numerals shall be located on the left lower side of each button.

For elevators serving a large number of floors, a keypad shall be installed at a maximum height of 1200 mm to ensure that all floors can be called, or a second buttons panel, placed horizontally, at a maximum height of 900mm.

The button to reach the facility's exit floor shall be raised at least 3 mm from the other buttons and be circled with a green line of at least 2 mm wide.

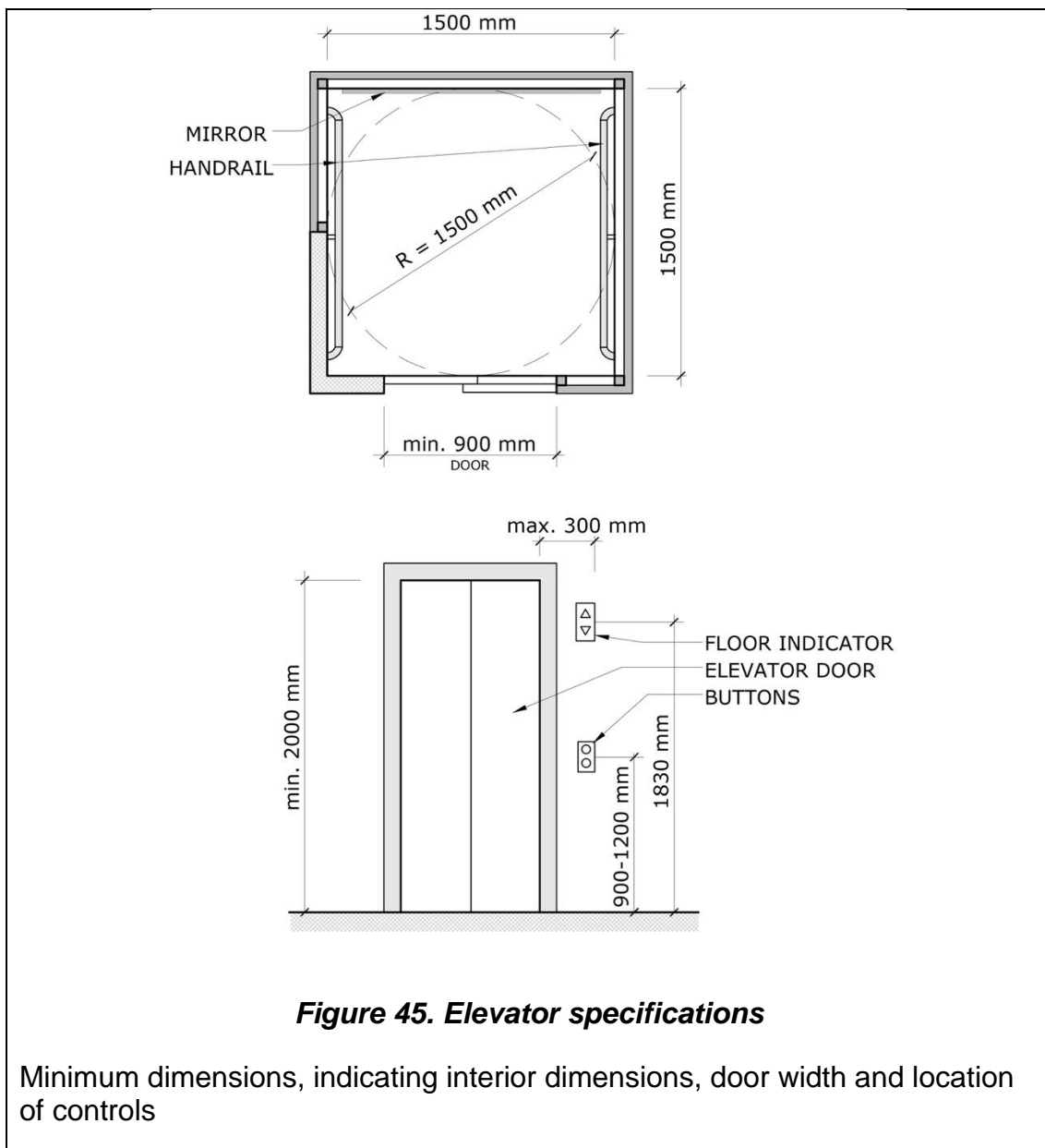
Call buttons in each floor can contain icons instead of digits in tactile and colour contrast against the background.

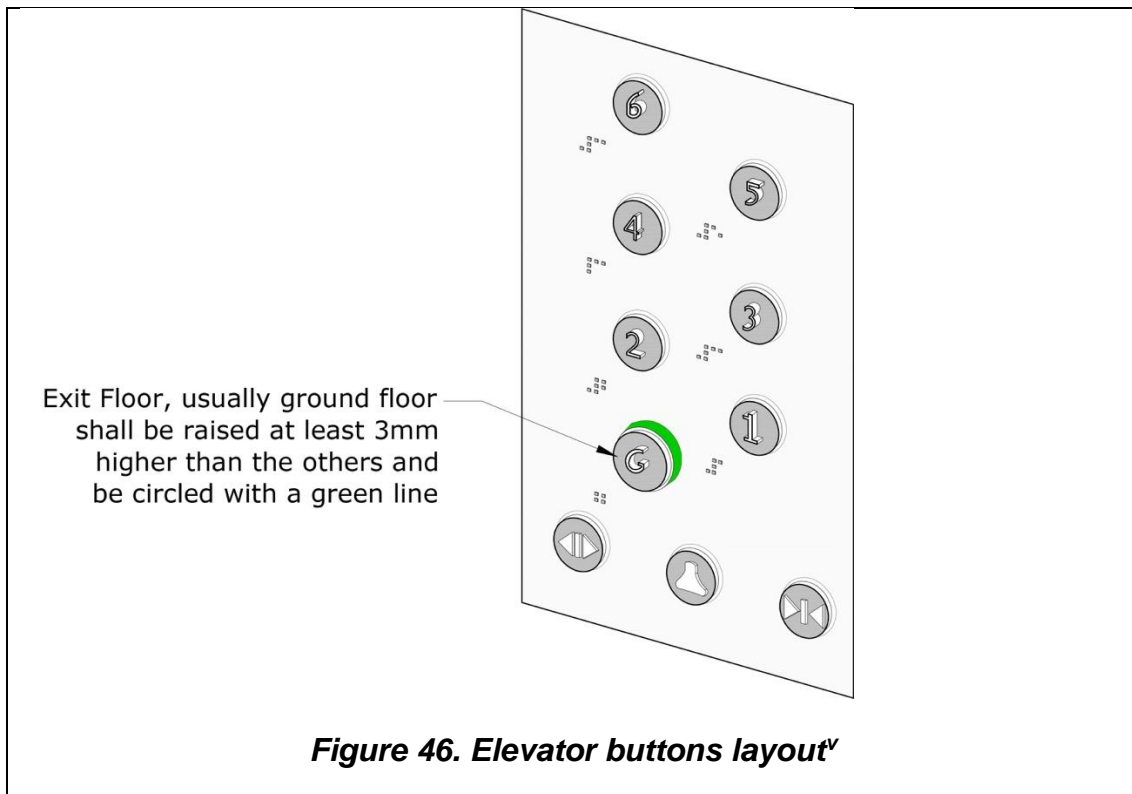
Buttons shall always provide a two-channel feedback when pressed: visual and acoustic or visual and tactile. Touch buttons and touch screens are not permitted.

Lights should be installed on the ceiling, providing a uniform illumination with a minimum of 100 lux. The illumination should not cause glare, reflection, confusing shadows or pools of light and darkness.

It must have a sign with graphic and tactile information, indicating the phone number of the alarm centre and the appropriate number to report an emergency.

The closing of doors shall be controlled by a user protection device and to ensure that doors reopen automatically if there is a person or any other obstacle in the doorway, and shall not produce a force greater than 135 N. Sensors should be located at two levels in the doorway to ensure that they detect lower items.





### 23.4 Lifting platforms<sup>vi</sup>

Vertical liftings platforms are an option in existing buildings where a conventional passenger elevator cannot be installed.

They can be of two types, depending on the use and maximum height:

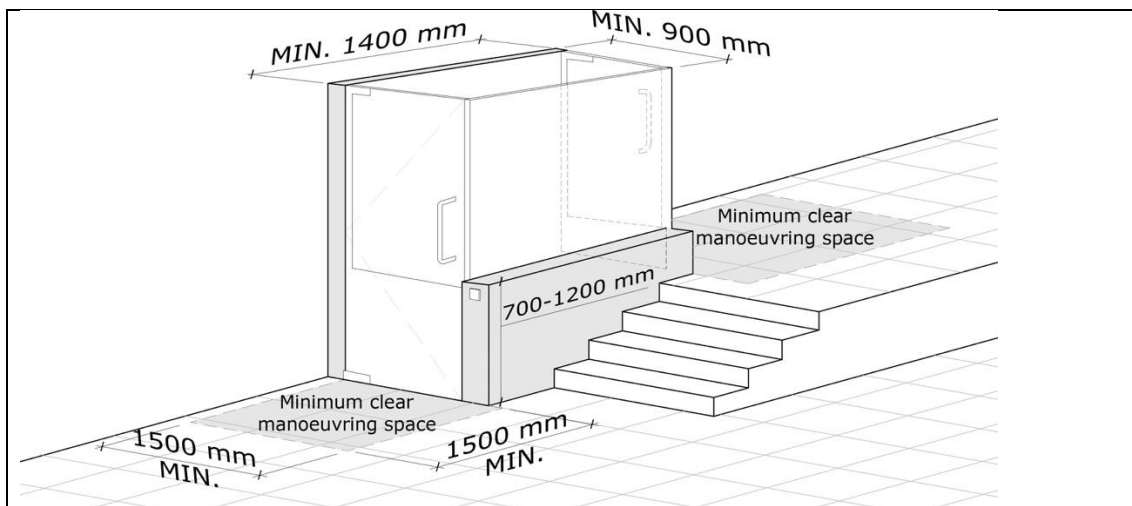
- Enclosed platforms.
- Non-enclosed platforms

A vertical lift platform must fulfil the following requirements:

- a) For enclosed platforms, the maximum allowed travel height is 4000 mm.
- b) For non-enclosed platforms, the maximum allowed travel height is 2000 mm, in public buildings and 3000 mm in private housing.
- c) If full height enclosure is not required, the minimum height of the partition shall be 1000 mm.
- d) The lift platform must have dimensions that allow its use by a wheelchair user.
- e) The platform has a clear usable area of 900 mm x 1400 mm (width x length).



- f) Access to the platform areas shall be free of obstacles in every landing with minimum dimensions of 1500 mm x 1500 mm.
- g) The lift-calling button shall be at a height between 700 mm and 1200 mm, in both ends, adjacent to a clear manoeuvring space.
- h) The platform's entrance or exit shall have minimum 900 mm width and be free of obstacles.
- i) It must have side protection separating users from the walls of the lift platform shaft.
- j) Inside the platform cabin, at least two handrails shall be placed at a height of 900 mm from the floor.
- k) The control buttons design shall be accessible. They shall have a continuous pressure button operation and shall be operable with one hand.
- l) There should be an additional external control for the platform that could be used by authorized personnel when necessary.
- m) The platform shall have doors in both ends, of either manual or automatic operation.



**Figure 47. Specifications for non-enclosed platforms**

The location of the platform may vary, according to the space design or barriers. The image shows a non-enclosed platform located by the side of a staircase, a common location for this type of platforms.

## 24 Ramps

Building should be designed to avoid the need for ramps on internal circulation routes. Curved ramps are not allowed.

In addition to a ramp, a flight of stairs should be provided if the change in level is more than 300mm. When the change in level is less than 300 mm, a ramp should be the only viable means of access and avoids the need of a single step.

Ramps should be used when a change in level has a gradient greater than 5%.

The maximum slope is 8% or 1:12 for ramps, and 12% or 1:8 for kerb ramps. The maximum cross fall gradient is 2%. The slope of a ramp must meet the specifications in Table 4:

Table 4. Ramps specifications<sup>vii</sup>

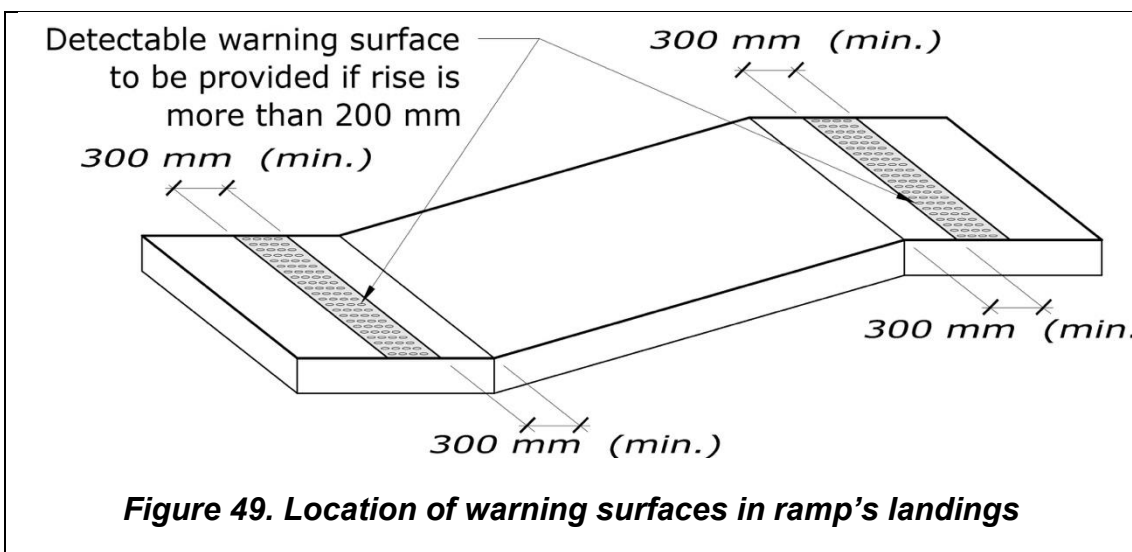
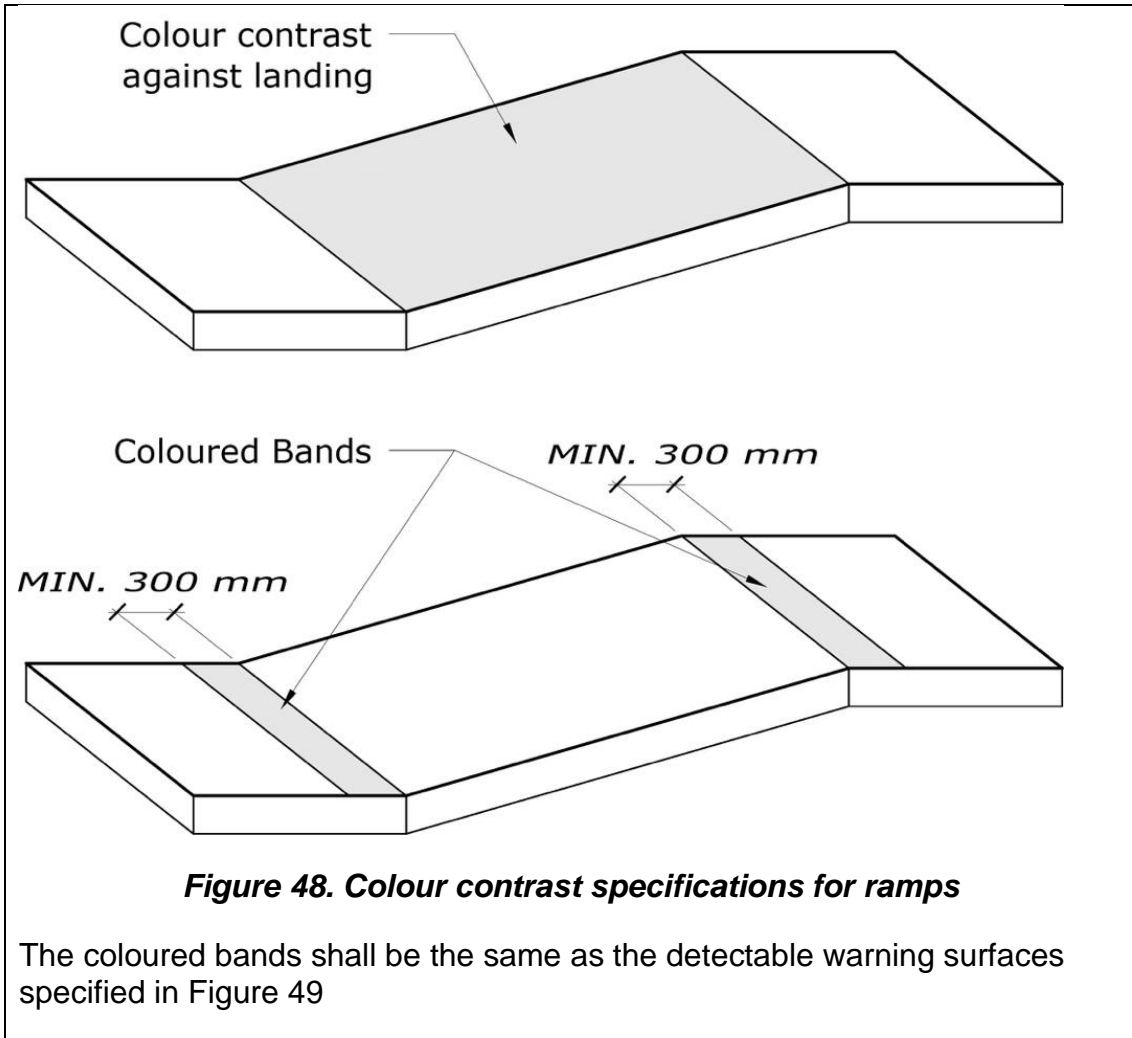
Max. rise, mm	Max. slope	Max. slope	Max. slope, mm/m	Max. length between landings, mm	Outdoor use	Indoor use	Handrails required		
no limit	Less than 1:20	Less than 5 %	<50	no limit	yes	yes	no		
500	1:20	5 %	50	10 000			yes	yes	yes
460	1:19	5 %	53	8 740					
420	1:18	5%	56	7 560					
385	1:17	6 %	59	6 545					
350	1:16	6 %	63	5 600					
315	1:15	7 %	67	4 725					
280	1:14	7 %	71	3 920					
245	1:13	8 %	77	3 185					
210	1:12	8 %	83	2 520					
180	1:11	9 %	91	1 980					
150	1:10	10 %	100	1 500					
110	1:9	11 %	111	990					
75	1:8	12%	125	600	threshold ramps only				

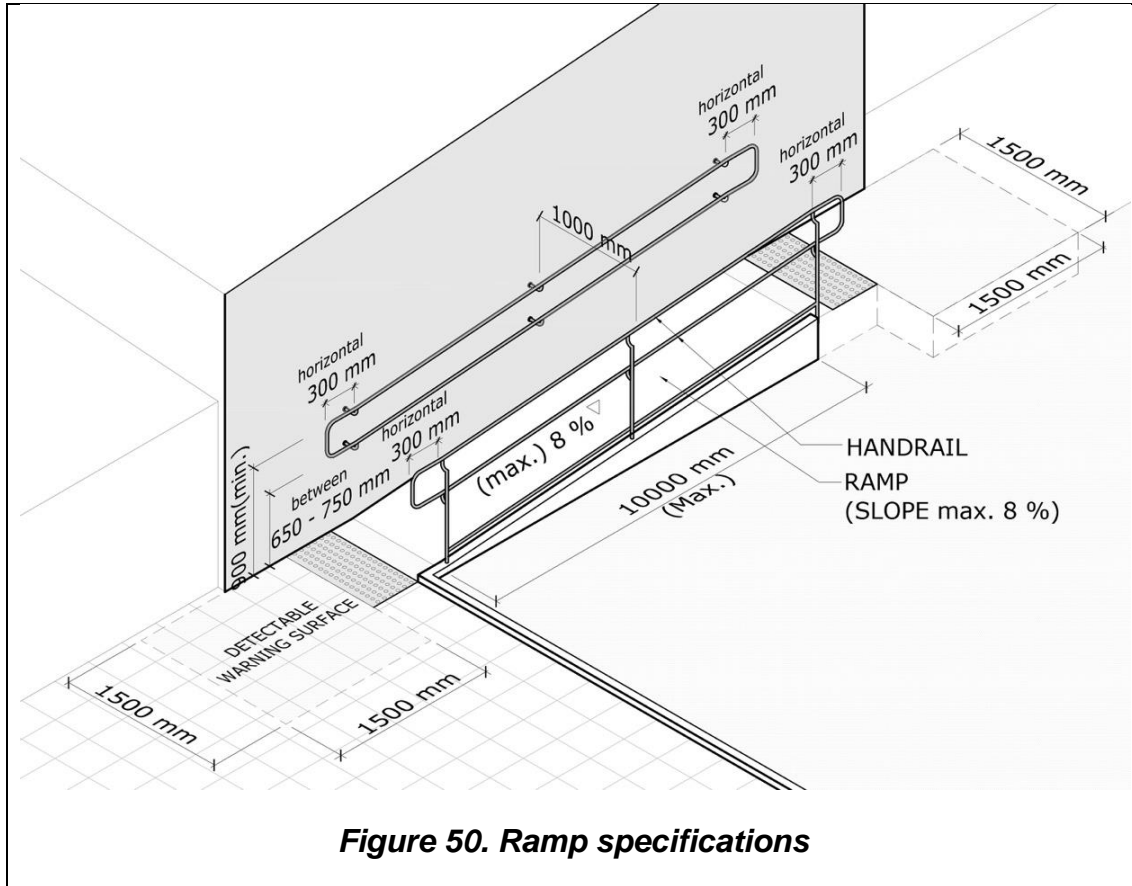
Ramp runs shall fulfil the following requirements:

- a) The maximum length is 10 meters between landings.
- b) The ramp's run usable width shall be 1000 mm.
- c) Ramp widths shall be free of obstacles. The usable width of 1000 mm is measured between the handrails. If the ramp is open, it shall have an outside edge protection or a lateral protection element of at least 100 mm in height.
- d) The beginning and the end of each ramp run shall have a warning surface following the requirements of Section 22.

Landings shall fulfil the following requirements:

- a) There are level landings required at the beginning and at the end of every ramp run. These landings shall have a minimum surface of 1500 mm x 1500 mm.
- b) Landings should be level with less than 2% slope in the direction of travel and crosswise directions.
- c) Corridors located in landings shall have no less than 1200 mm width.
- d) Doors shall be located at least 1500 mm away from the start or end of each ramp run.
- e) Artificial lighting should be evenly distributed, with an illuminance at the ramp and landings of at least 100 lux.





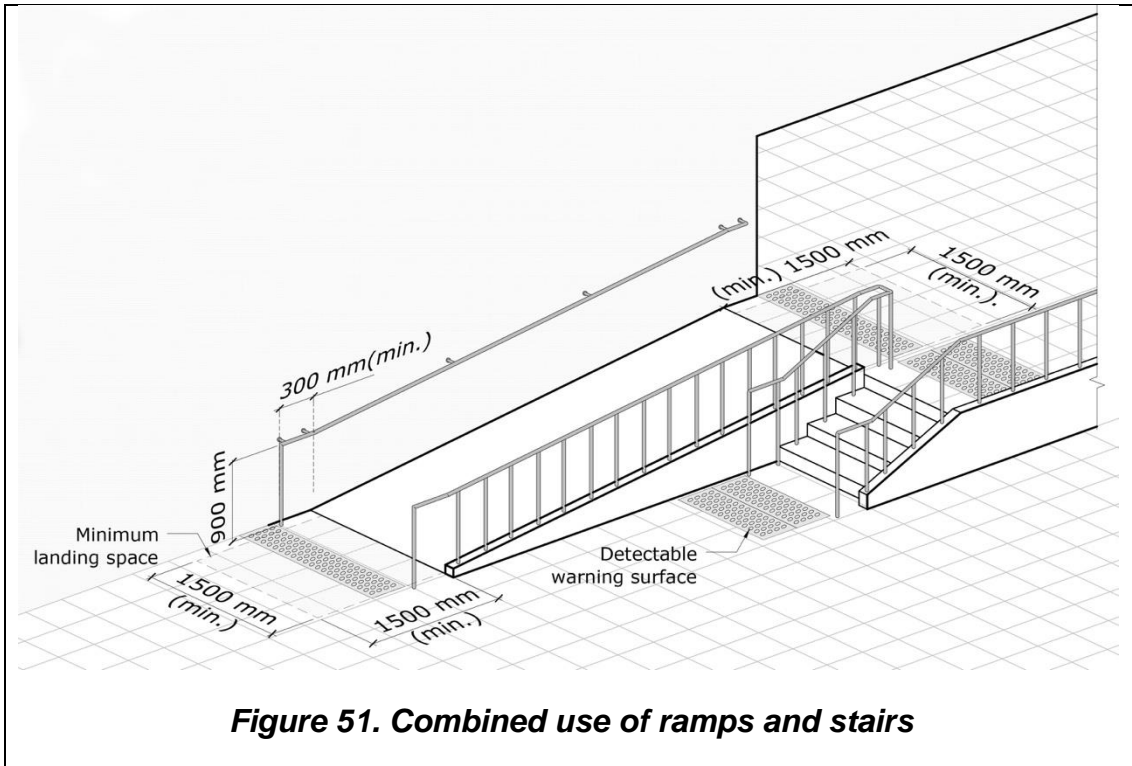
The above Figure 50, shows ramps specifications with maximum allowed gradient and length. The final length and gradient of an individual ramp may vary depending on the height to cover, according to Table 4 and available space for its construction.

In any case, the gradient for one single run shall not be more than 8% and the maximum length shall not be more than 10 meters between landings.

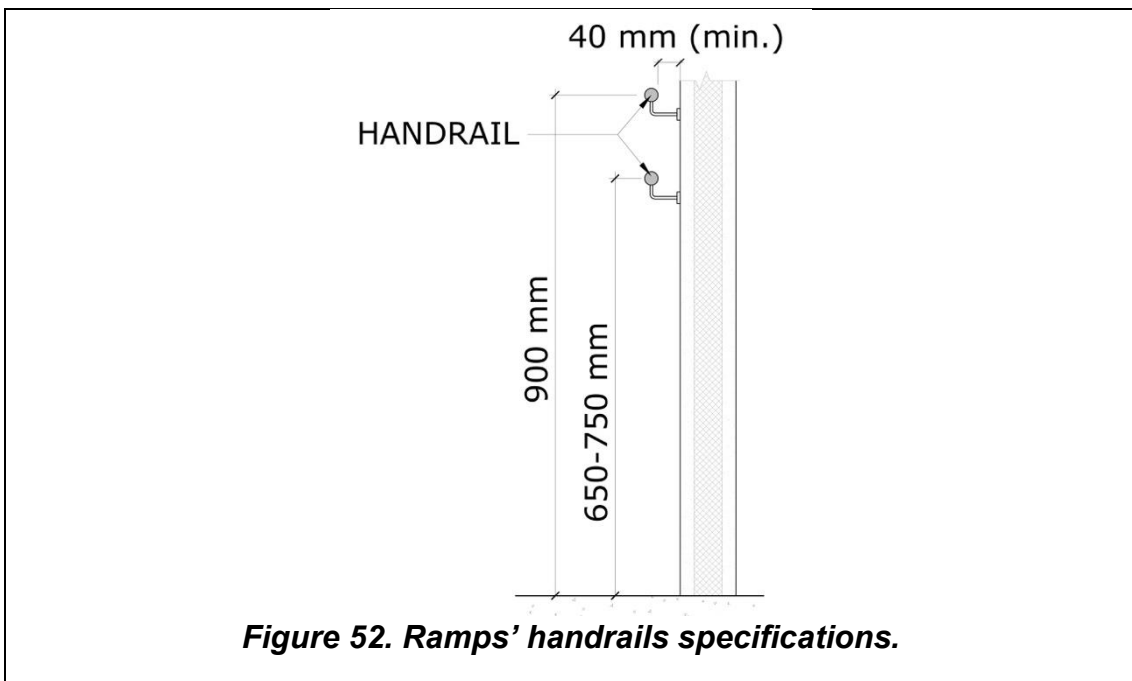
To comply with these measurements, a multi-sections ramp may be needed, with one or more runs and/or landings.

## 24.1 Temporary ramps

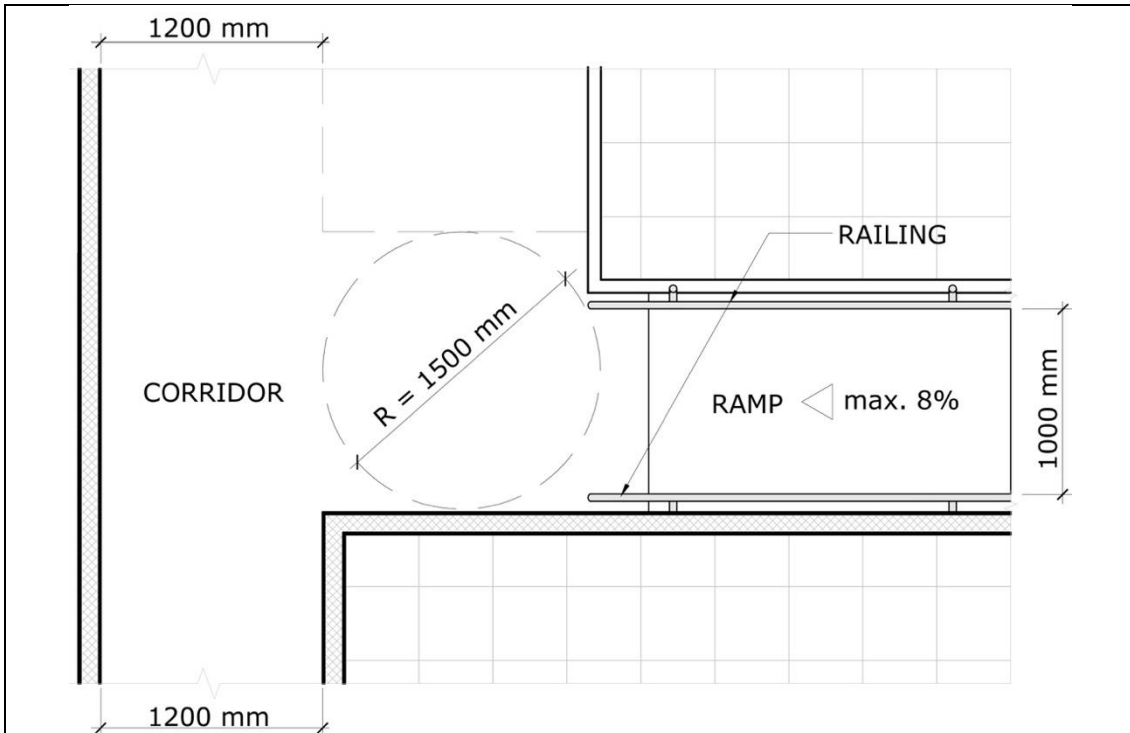
Temporary ramps to provide temporary solutions when a permanent ramp is not possible, or during building or maintenance works, shall be designed in accordance to this section.



**Figure 51. Combined use of ramps and stairs**

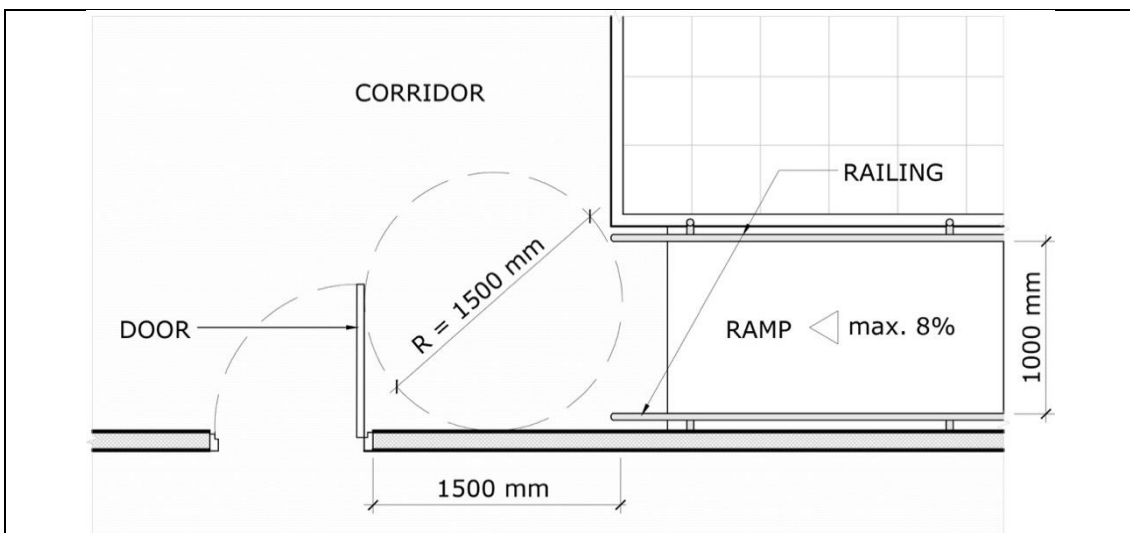


**Figure 52. Ramps' handrails specifications.**



**Figure 53. Intersection of ramp and corridor**

The ramp shall have a landing area if intersecting with a corridor



**Figure 54. Clear space between ramp and doors**

The ramp shall have a landing area if nearby a door

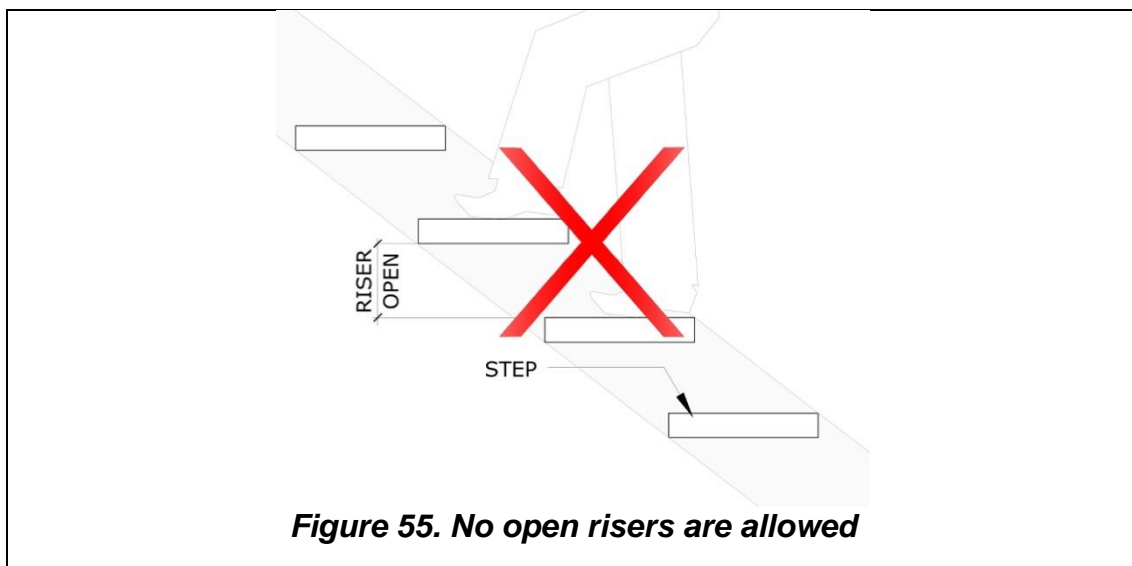
## 25 Stairs

Curved stairs should be avoided as the variable steps' width may prevent providing the required specifications as described below.

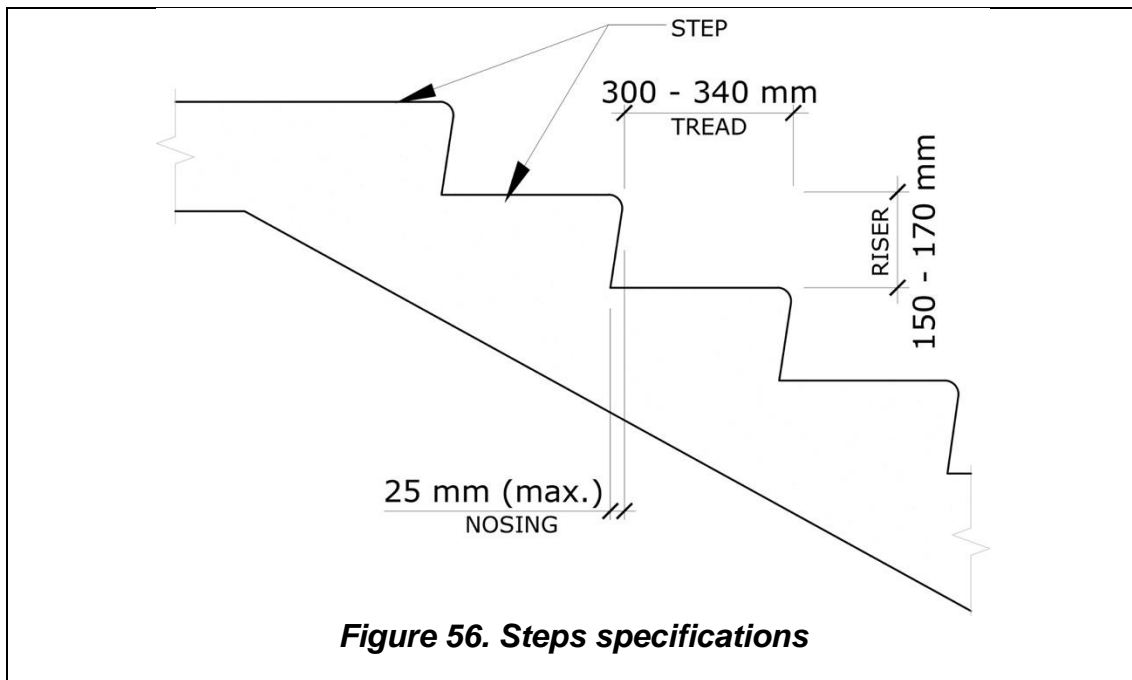
### 25.1 Steps

Steps shall the following characteristics:

- Rises shall have a maximum height between 150 mm and 170 mm.
- In straight flights, the dimension of the stair tread must be between 300 mm and 340 mm.
- The rise (R) and tread (T) must meet the following relation:  $640 \text{ mm} < 2R + T < 680 \text{ mm}$ .
- No open risers or discontinued treads are allowed.
- The run of a step is the dimension measured from the edge of the nosing of a tread to the vertical projection of the nosing of the next step.
- All steps shall be fitted with non-slip nosing strips between 50 mm and 65 mm in width, with permanent contrasting colours.
- The tread and rise shall have contrasting colours.







## 25.2 Stair flights

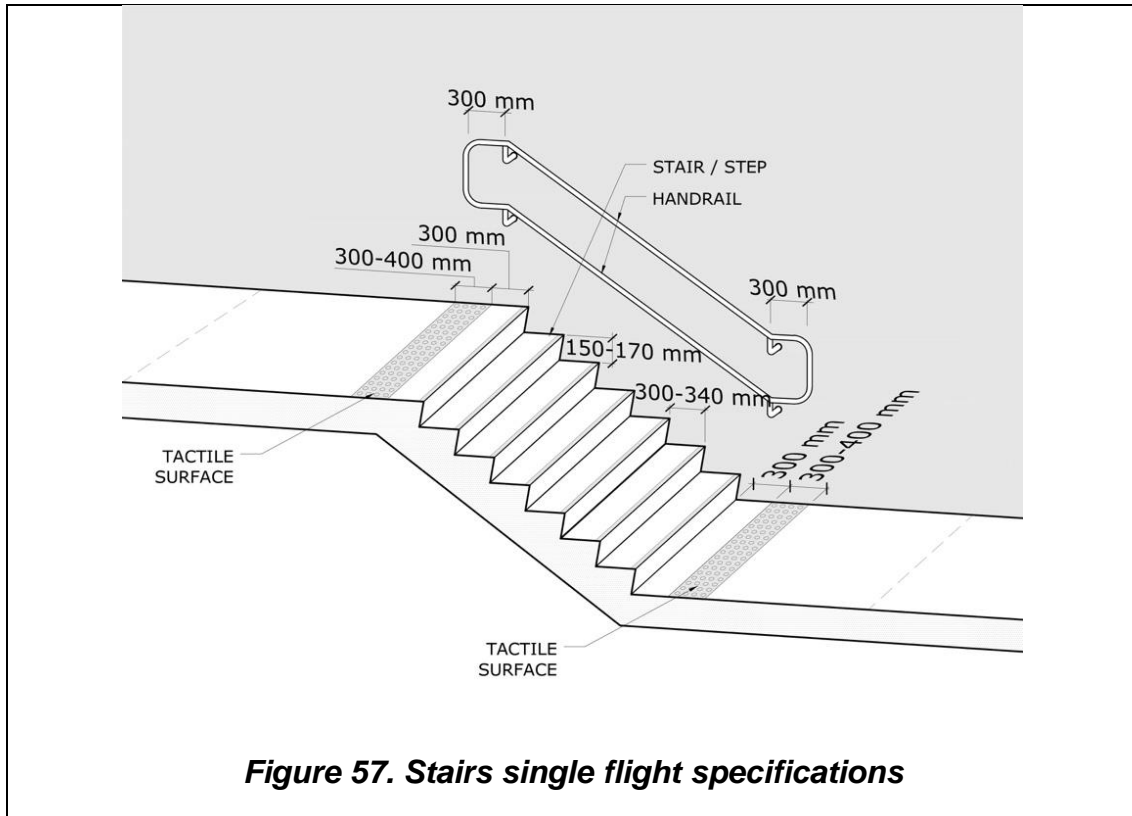
Each stair flight must meet the following characteristics:

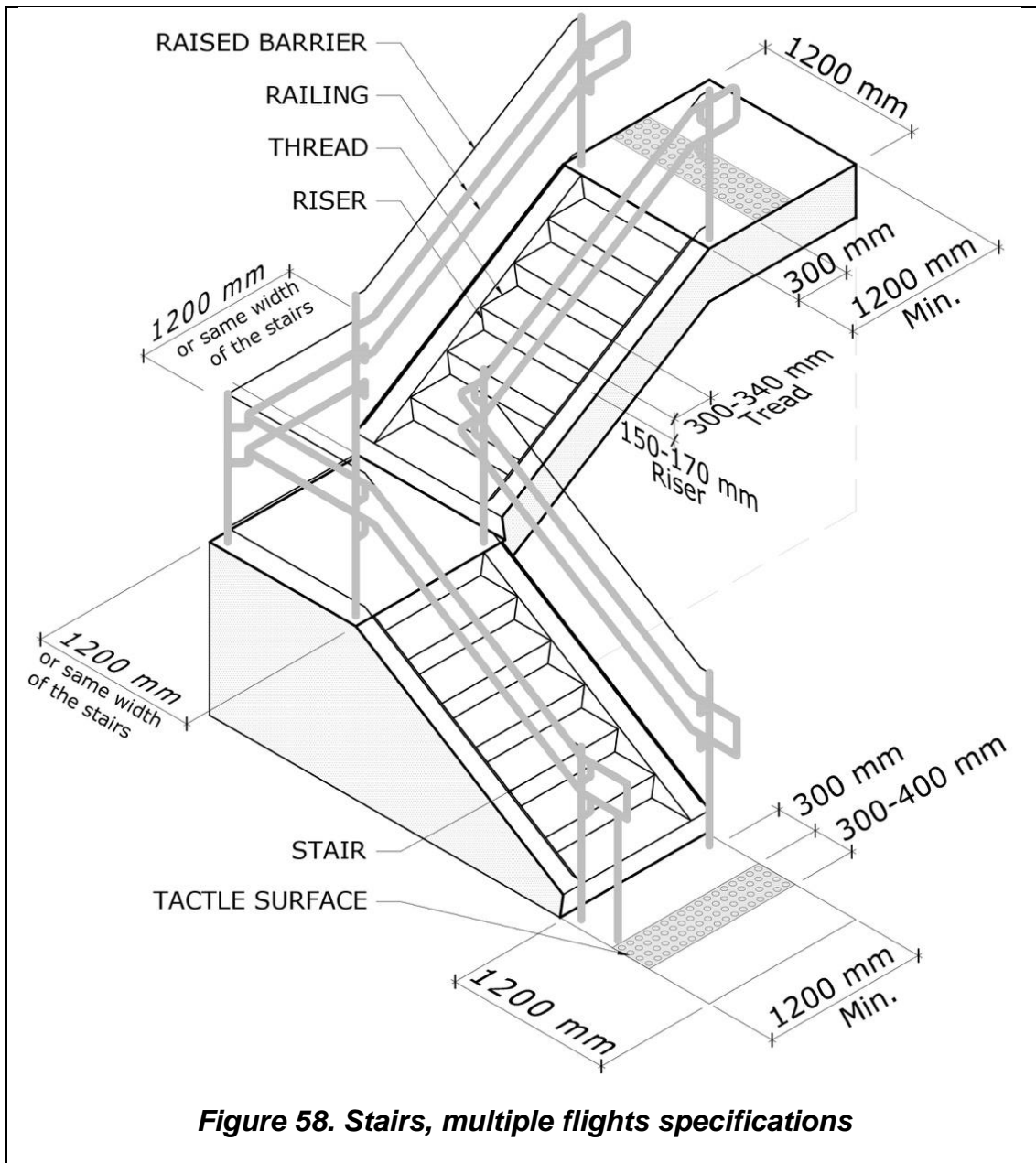
- A detectable warning surface shall be provided at the beginning, end and intermediate landing of each stair flight.
- Each flight shall have between 3 steps and maximum of 12.
- The usable width of the flight shall be at least 1200 mm.
- The width of stairs should be free of obstacles overhead, particularly the underside of the stairs themselves. The minimum usable width is measured between walls or guardrails, without deducting the space occupied by the handrails as long as they do not protrude from the walls or guardrails more than 120 mm.
- Illumination at the top and bottom and along of the flight should be, at least 200 lux.

Each stair landing must meet the following characteristics:

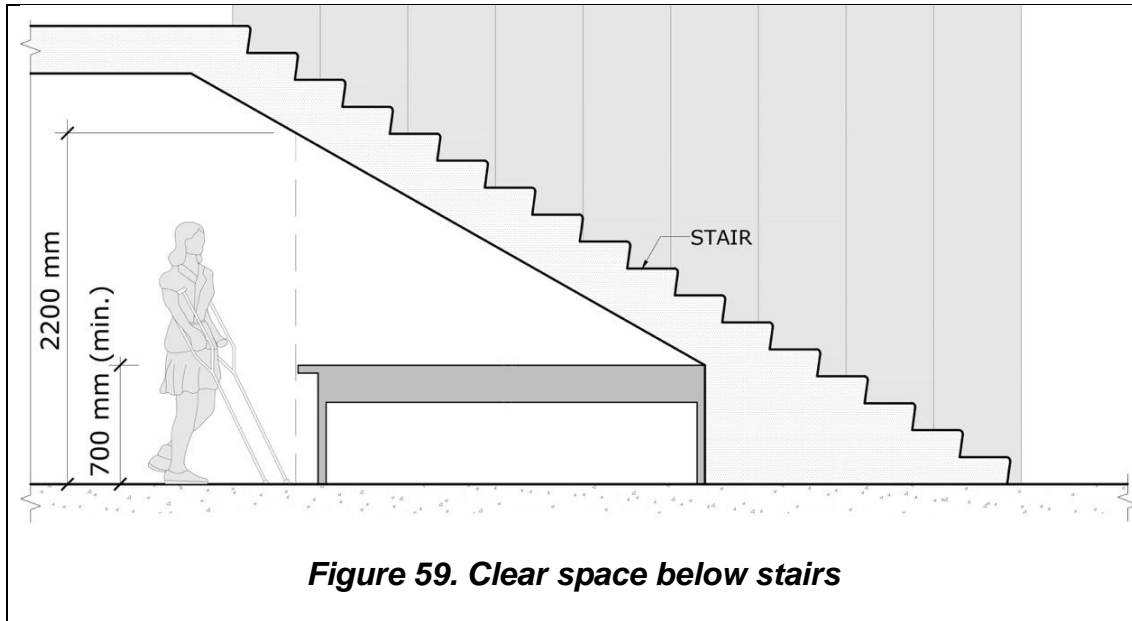
- Landings located between stairs flights in the same direction should maintain at least the same stair width and have a minimum length of 1200 mm.

- b) When there is a directional change between two flights, the width of the landing shall not be reduced. This width must be free of obstacles and free from any door opening.





- c) Where the headroom under a stair in a pedestrian area is reduced to less than 2200 mm from the floor, a guardrail or other barrier shall be provided with a minimum height of 700 mm.



### 25.3 Escalators

Escalators are not suitable for people with buggies or wheelchair users.

An alternative shall be where an escalator is used as the main means of access. Signs shall direct people the alternative means of access

## 26 Toilet and sanitary rooms<sup>viii</sup>

The requirements contained in this section apply to buildings and facilities for public use, for example: work places, parks, hotels, sport and recreation facilities, parks, public buildings.

At least one accessible toilet for each gender and in every bank of toilets shall be accessible.

If only one toilet for each gender is provided, then it must be accessible.

The accessible toilet room shall always contain a washbasin.

Public toilet shall have non-slippery floor surfaces.

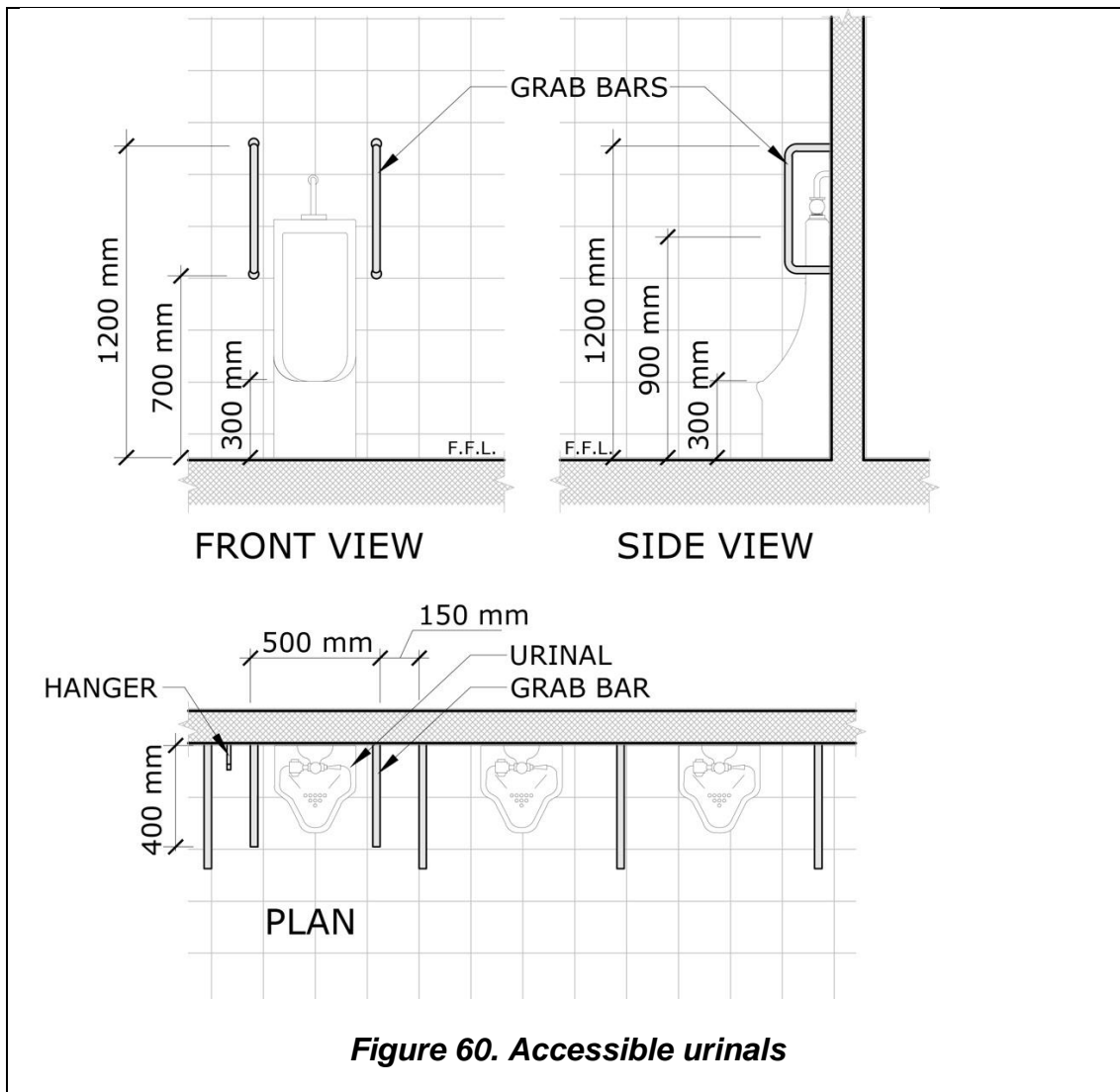
## 26.1 Accessible urinals

If urinals are provided, at least one urinal shall be accessible according to the following requirements:

Urinals that reach the floor are preferred as they can accommodate users of different heights. The bottom lip should be at a maximum height of 300 mm.

Grab bars shall be provided on both sides of the urinal, have a minimum height of 600 mm, mounted vertically with the lower point of the grab bar located at a maximum height of 700mm from the floor level

Where privacy screens are provided there should be a clearance of 920 mm between them and shall not extend beyond the front edge of the urinal rim



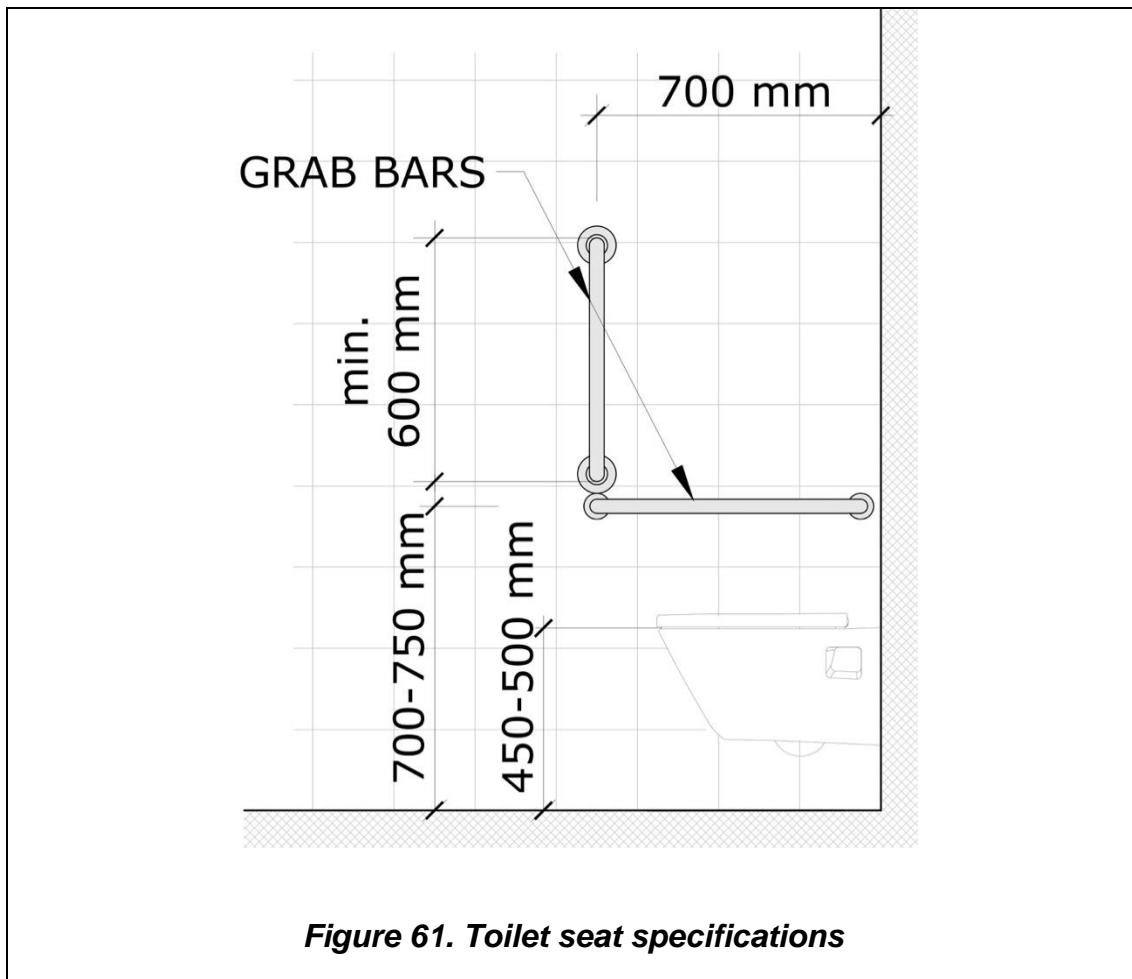
## 26.2 Toilet bowl and seat

The top of the toilet seat shall be between 450 mm and 500 mm.

The minimum distance from the edge of the toilet seat to the rear wall should be between 650 mm and 800 mm.

The minimum distance of a corner toilet from the pan to the adjacent wall should be 250 mm, and from the centre line of the toilet to the adjacent wall should be 450 mm.

Toilet bowls without water tank shall provide a back support, as showed in Figure 62.



### 26.3 Accessible individual toilets

Accessible toilet compartments can be located either inside of the cluster of toilets provided for each gender or outside the cluster of toilets.

If the individual toilet compartment is outside the cluster of toilets, it shall be located adjacent to the cluster or at a very short distance of each gender's cluster.

In facilities with small internal areas without enough space to provide regular toilets and accessible toilets, there should be at least one accessible toilet compartment for each gender available to all users.

Family toilets should be located outside of the cluster of toilets.

Accessible toilets shall fulfil the following requirements:

The door should have a clear width of 900 mm and comply with Doors section of this Code.

Furniture shall have a reflectance contrast with the walls of at least 30 points LRV (Light Reflectance Value).

Every cabin door shall be provided with a latch operable with one hand, located between 900 and 1200 mm and a coat hanger installed between 1100 and 1200 mm.

The clear manoeuvring space at floor level in front of the toilet seat and washbasin shall be 1500 mm x 1500 mm.

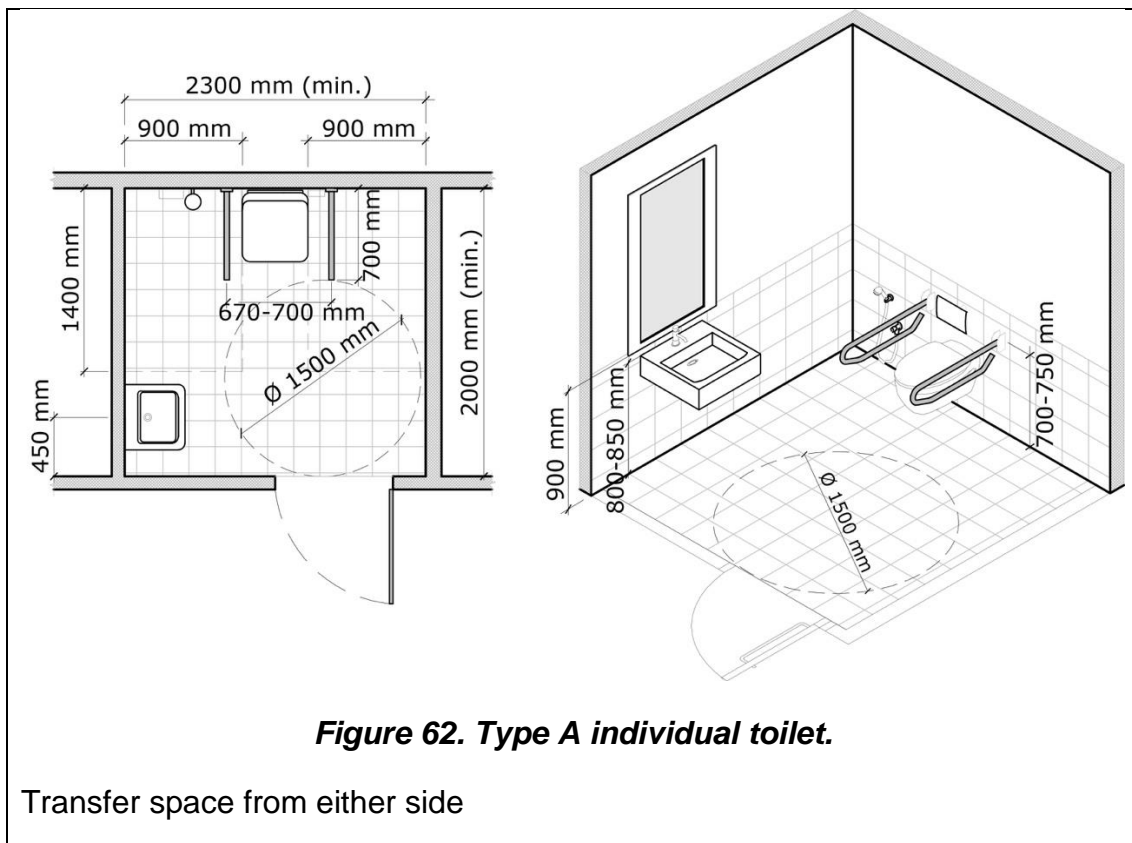
Each toilet block for both genders shall include a baby changing table duly marked.



## 26.4 Type A individual toilet, lateral transfer from both sides

Characteristics:

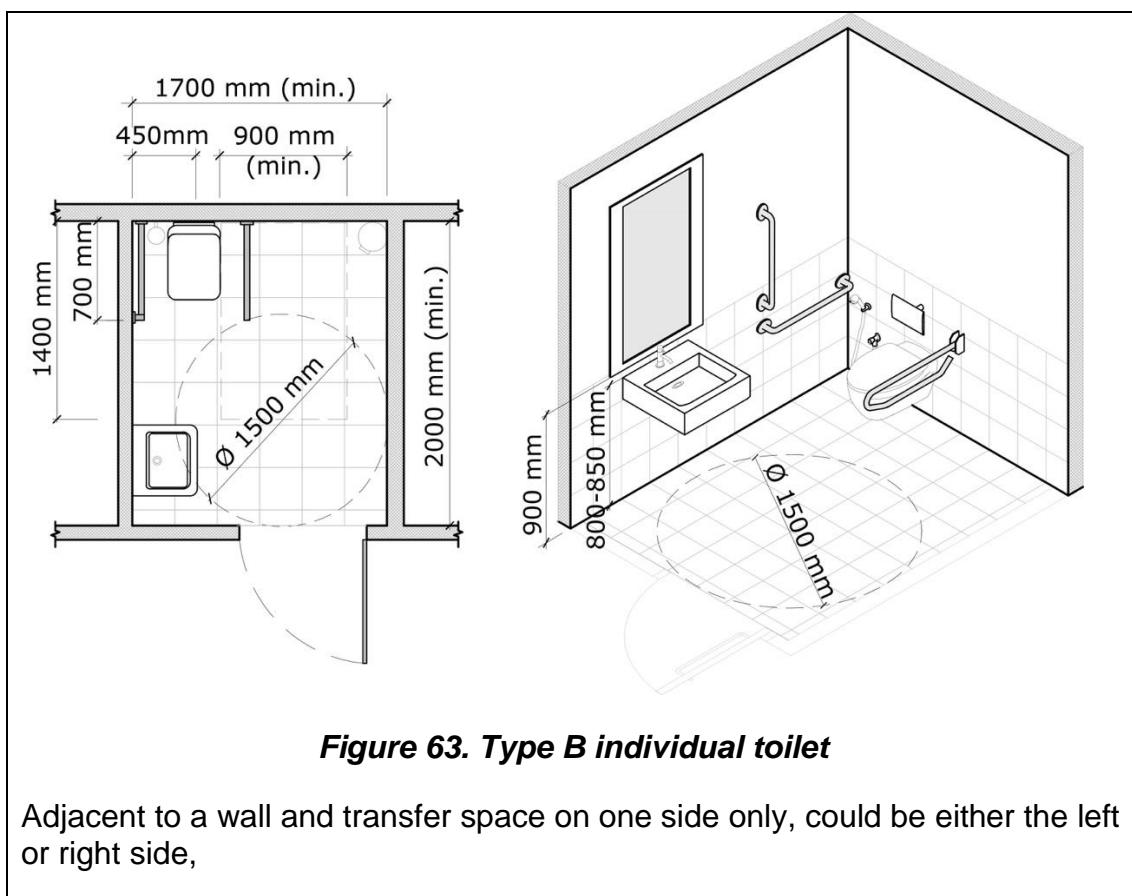
- Lateral transfer space from both sides of the toilet.
- The minimum free clearance besides the toilet shall be 900 mm.
- Manoeuvring space uninterrupted by washbasin.
- Independent water supply besides toilet seat, right hand side.
- Horizontal foldable grab bar at both sides that should overlap the front edge of the seat between 100 mm and 250 mm.
- Toilet paper dispenser on both folding grab bars.
- A changing table shall be provided in all accessible toilet rooms.
- Minimum dimensions are 2300 mm x 2000 mm.



## 26.5 Type B corner individual toilet room

Characteristics:

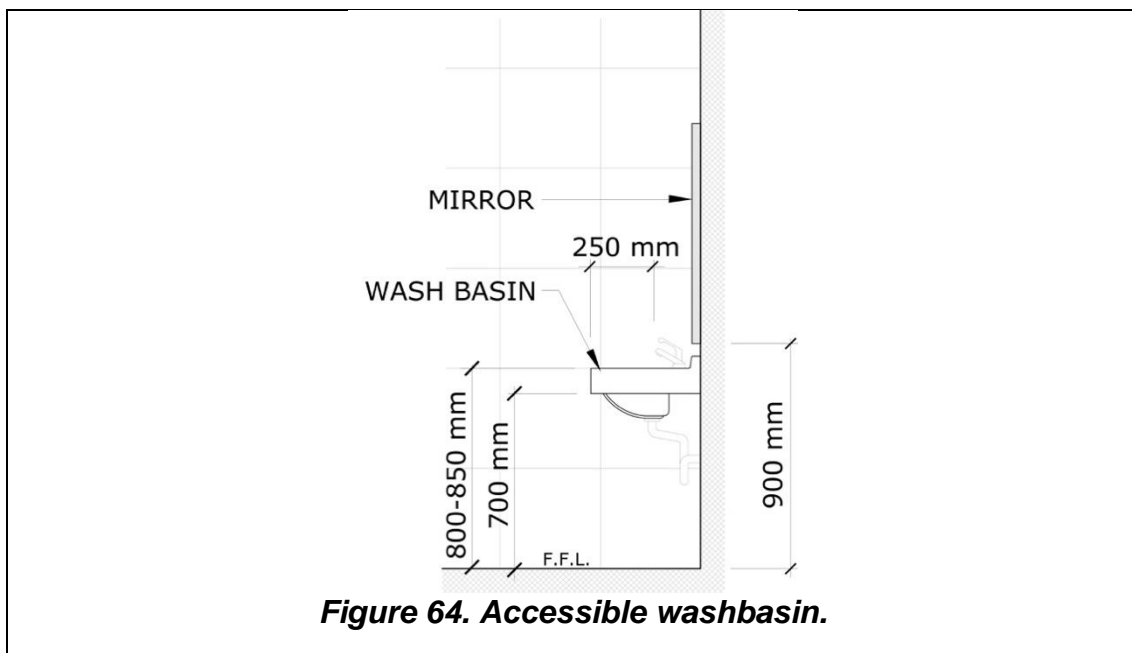
- Lateral transfer only from one side.
- The minimum free clearance besides the toilet shall be 900 mm.
- Manoeuvring space uninterrupted by washbasin.
- Independent water supply besides toilet seat, right hand side.
- Horizontal grab bar at a height of 200mm to 250 mm above the toilet seat and extend a minimum of 150mm from the front end of the seat.
- Vertical grab bar beside the toilet seat, above the horizontal bar, with a length of minimum 600 mm, as specified in Section 24.2, Figure 61.
- Foldable grab bar on the transfer side.
- Toilet dispenser fixed on the wall beside the toilet seat.
- Minimum dimensions are 1700 mm x 2000 mm.



## 26.6 Washbasins

Washbasins shall meet the following requirements:

- a) Washbasins shall not be the pedestal type and shall have clear knee space below.
- b) Clear knee space dimensions are a minimum 700 mm high and 250 mm deep, from the faucet to the edge.
- c) The usable surface height shall be between 800 mm and 850 mm.
- d) When washbasins are in a row at least one shall be possible to use with all the accessories, such as soap and paper towel dispensers.
- e) Faucets shall be operated by pressure with a lever handle, operable with a closed fist, or be sensor operated. Turning or pressure systems that require great effort to be operated are not allowed.
- f) The distance from the washbasins edge to the faucet shall be less than 600 mm and its height from the floor shall be between 900 mm and 1200 mm.
- g) The lower edge of the mirror shall be mounted at a 900 mm height or less.
- h) The pipes under the washbasins should be recessed or otherwise covered to avoid contact with a wheelchair user's knees.
- i) Shall not interfere with the manoeuvring space of wheelchair users while transferring to the toilet bowl.



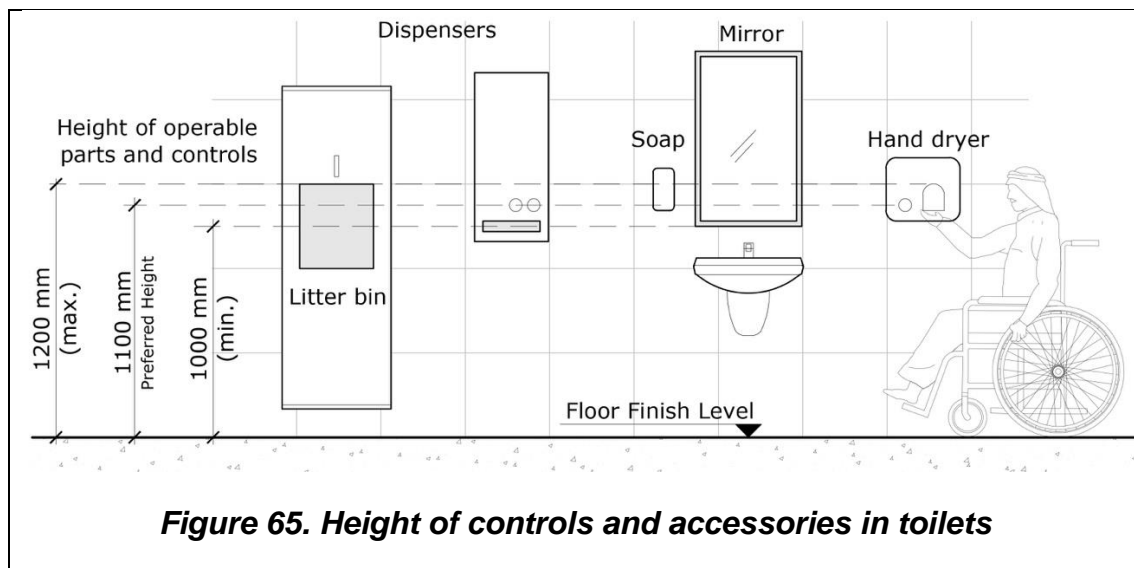
## 26.7 Restroom's control and accessories

All controls and accessories shall meet the following requirements:

Flushing systems shall be operated by sensor or with a flush handle.

Controls shall have a large surface and are operable with one hand only.

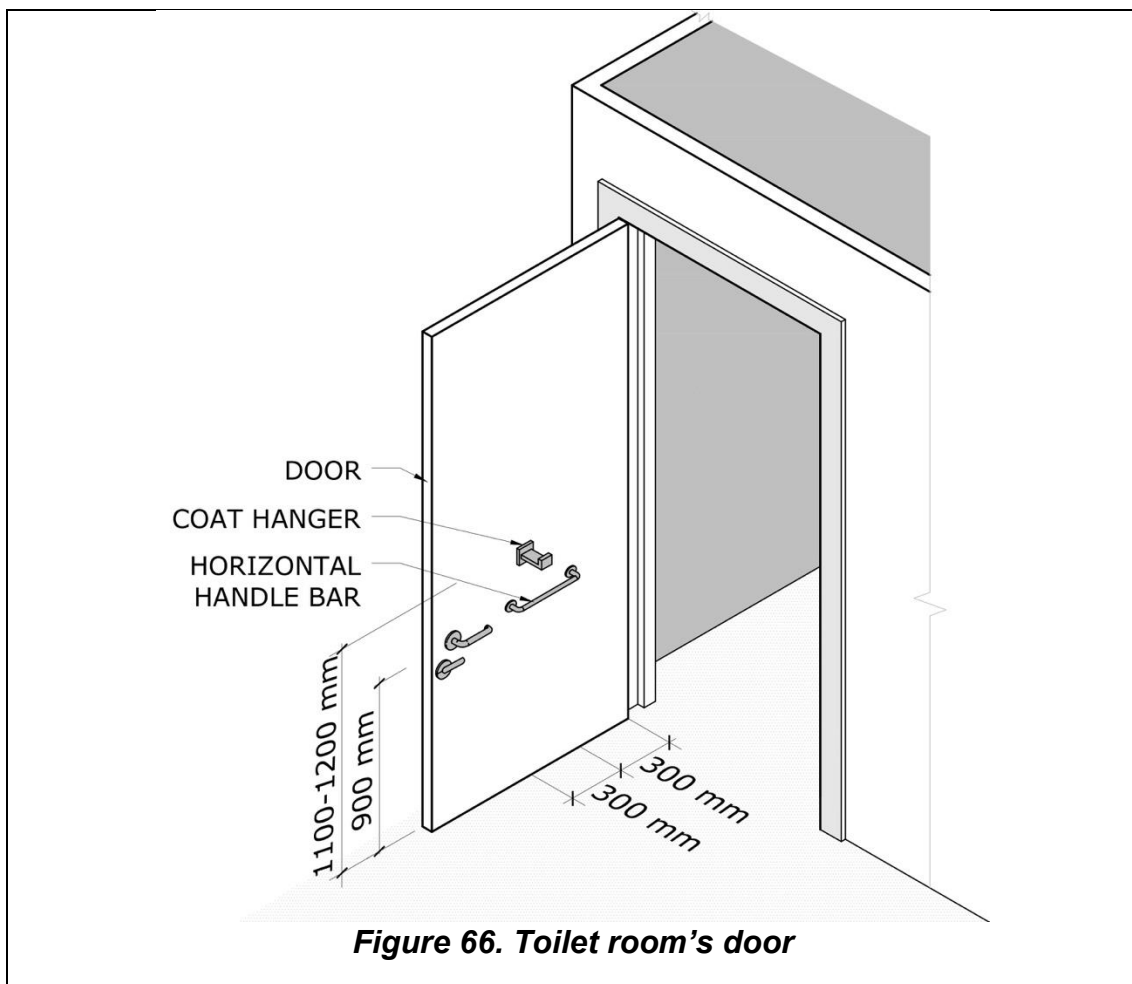
Controls and accessories such as soap dispensers or dryers, shall be mounted at a height between 700 mm and 1200 mm.



## 26.8 Toilet rooms doors

Doors must meet the following requirements:

- a) Unobstructed width of at least 900 mm.
- b) Fulfil the door criteria set out in the Door section of this code.
- c) Open outwards or be sliding.
- d) A horizontal handle bar with a length of 300 mm shall be placed at a height between 900 mm and 1000 mm at 300 mm from the hinge side on the inside of the door and by the latch side on the outside of the door.

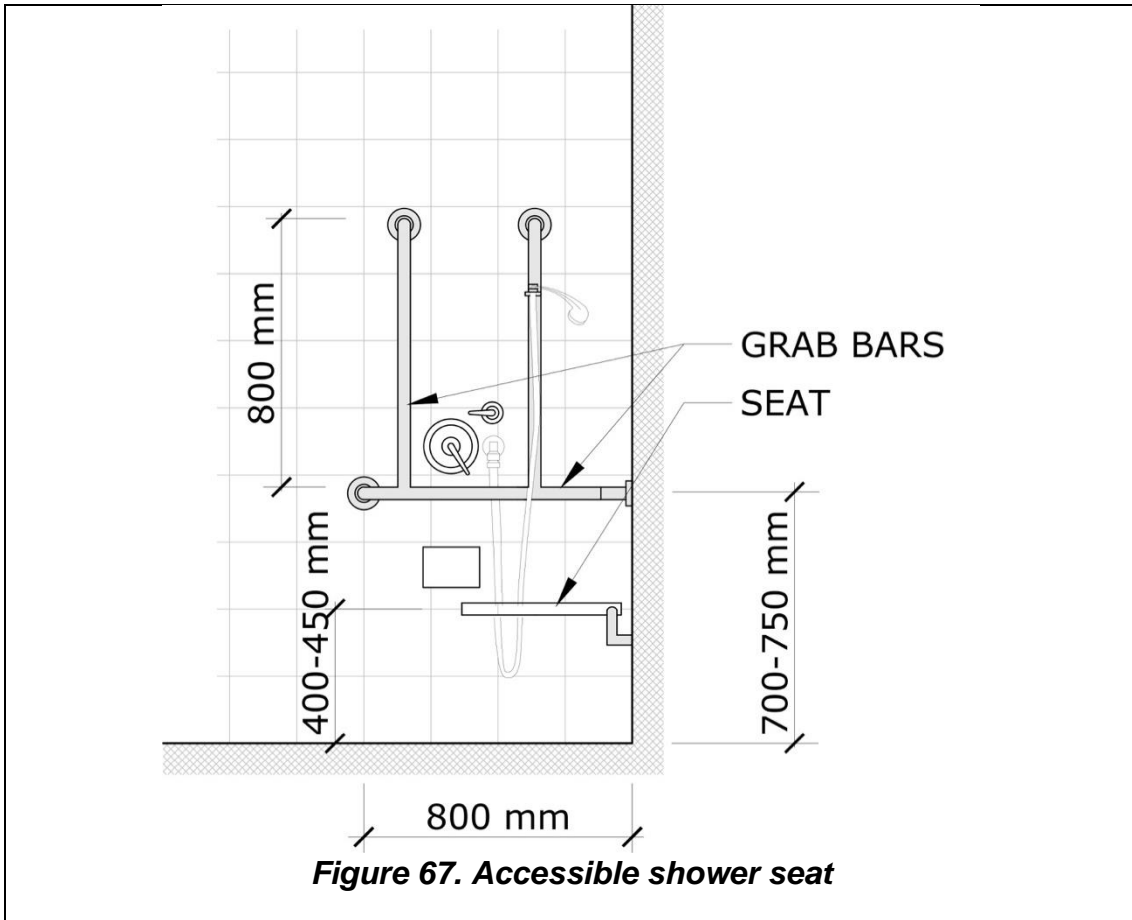


## 26.9 Accessible showers

Where showers are provided, at least one shall be accessible.

Showers shall meet the following requirements:

- a) The shower floor surface shall be flush with the level of the surrounding area. The maximum slope for water evacuation is 4%.
- b) If a shower is provided it shall have a minimum dimension of 900 mm x 1300 mm and have a seat of at least 400 mm x 400 mm. This seat shall be located at a height between 450mm and 500 mm from the floor and be separated from the wall between 150 mm and 200 mm. The seat shall be free of sharp edges. Adjustable height seats are preferred; especially in hotels and residences.
- c) Accessible showers shall have a horizontal grab bar to assist in transferring and a vertical one for support. The horizontal bar shall have a length of 800 mm and be mounted at a height of 700 mm to 750 mm from the floor level in the wall beside the shower seat. The vertical bar with a length of 800 mm shall be installed in the lateral wall of the shower seat at a height of 800 mm. The distance between both bars installed on both sides of the shower seat shall be between 670 mm and 700 mm.
- d) Alternative systems such as bath chairs with the same features can be provided.
- e) Controls shall be within 500 mm of the seat.



## 27 Family-friendly facilities

The provision of family friendly facilities for nursing women, young children and persons with disabilities requiring the assistance of caregivers shall apply to the following buildings:

- Transport stations, airports.
- Sport complexes and public swimming pools.
- Theme parks and purpose-built family amusement centres.
- Large scale shopping and multi-purpose complexes of size more than 10,000 sqm. in gross floor area.

The following facilities shall be provided:

- a) At every level where toilets are provided:
  - 1 family toilet for each block of toilets
- b) At least one feeding room at an appropriate location. If they facility is family oriented, a dual feeding room may be provided.
- c) At least one child protection seat
- d) Seating areas at appropriate locations along frequently accessed routes and spaces

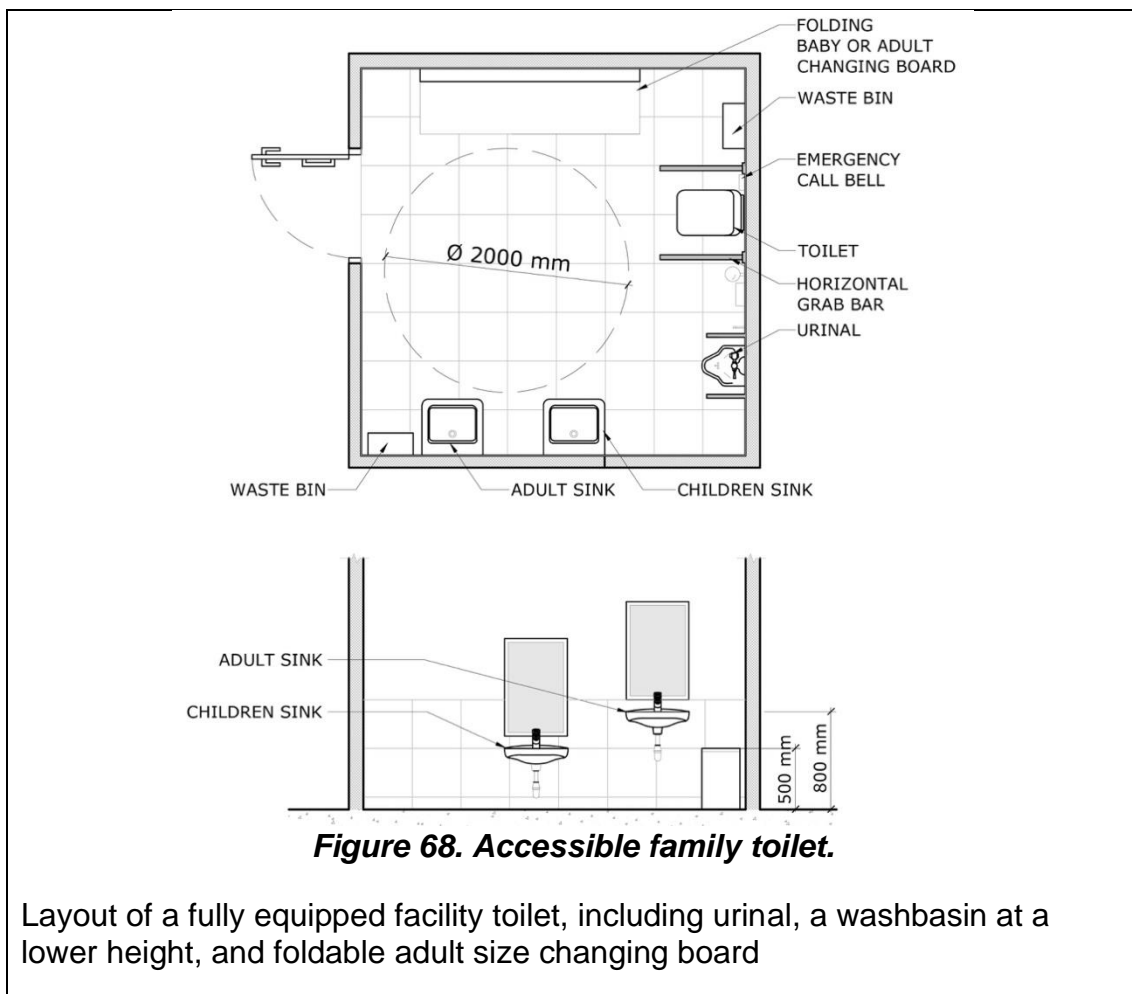


## 27.1 Family toilets<sup>ix</sup>

It is recommended 1 family toilet for each block of toilets. At least 1 family toilet within 300 m distance from any part of the building shall be provided.

A family toilet is considered accessible when it meets the requirements specified for accessible toilets and following these specifications:

- It provides a second washbasin at a height of 500 mm from the floor.
- There is a clear manoeuvring turning space of at least 2000 mm diameter free of obstacles.
- In addition to the toilet, a urinal shall be provided with a usable height of 400 mm.
- There is a diaper changing station for babies. It is recommended to include an adult sized changing board instead.
- An emergency call button shall be provided.

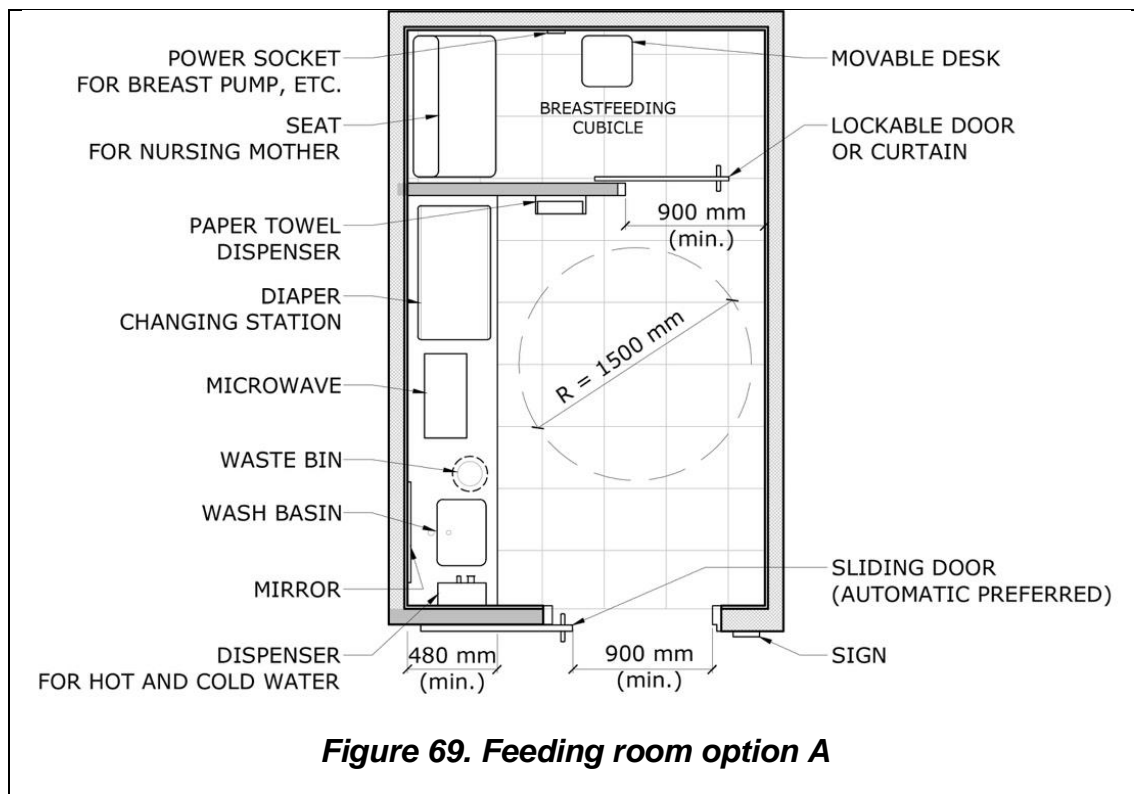


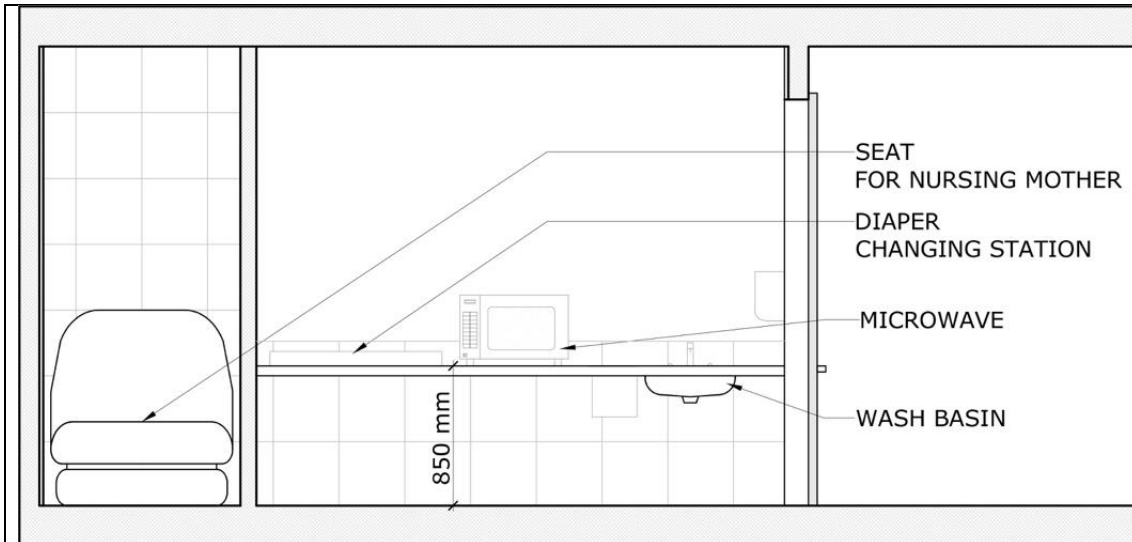
## 27.2 Feeding rooms<sup>x</sup>

A feeding room shall meet the following requirements:

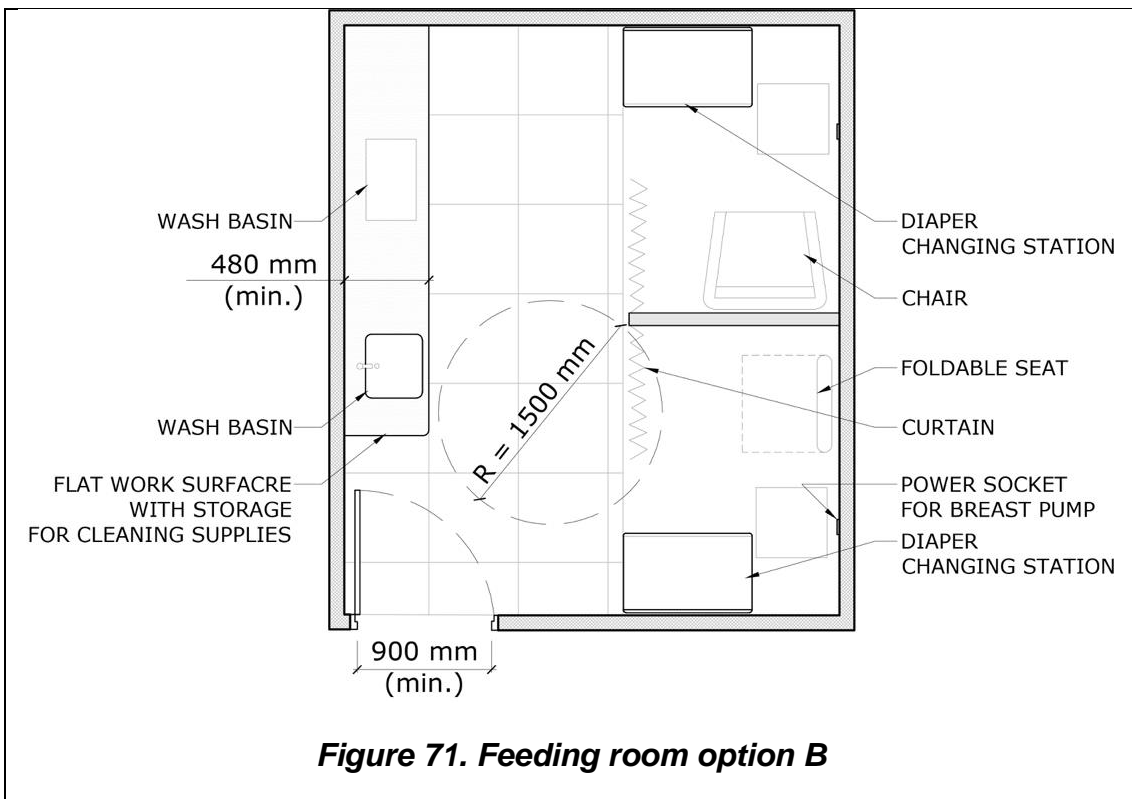
- Its surface shall be at least 7 sq. meters for individual feeding rooms and 10 sq. meters for dual feeding rooms.
- Its design should ensure an ease of movement with a pram and a child on the arms.
- It shall have proper ventilation for any smell generated by the diaper waste bins as well as proper place for the diaper waste bins.
- Furniture shall have a reflectance contrast with the walls of at least 30 points LRV (Light Reflectance Value).

Two examples are provided below. All elements and appliances described in the following Figures 69, 70 and 71 shall be provided although not necessarily with the same distribution.





**Figure 70. Feeding room option A, elevation.**



**Figure 71. Feeding room option B**

### 27.3 Child protection seats

Shall be located either in:

- a) One of the water closet compartments in both males and females' toilet blocks.
- b) Family toilet.

### 28 Ablution areas<sup>xi</sup>

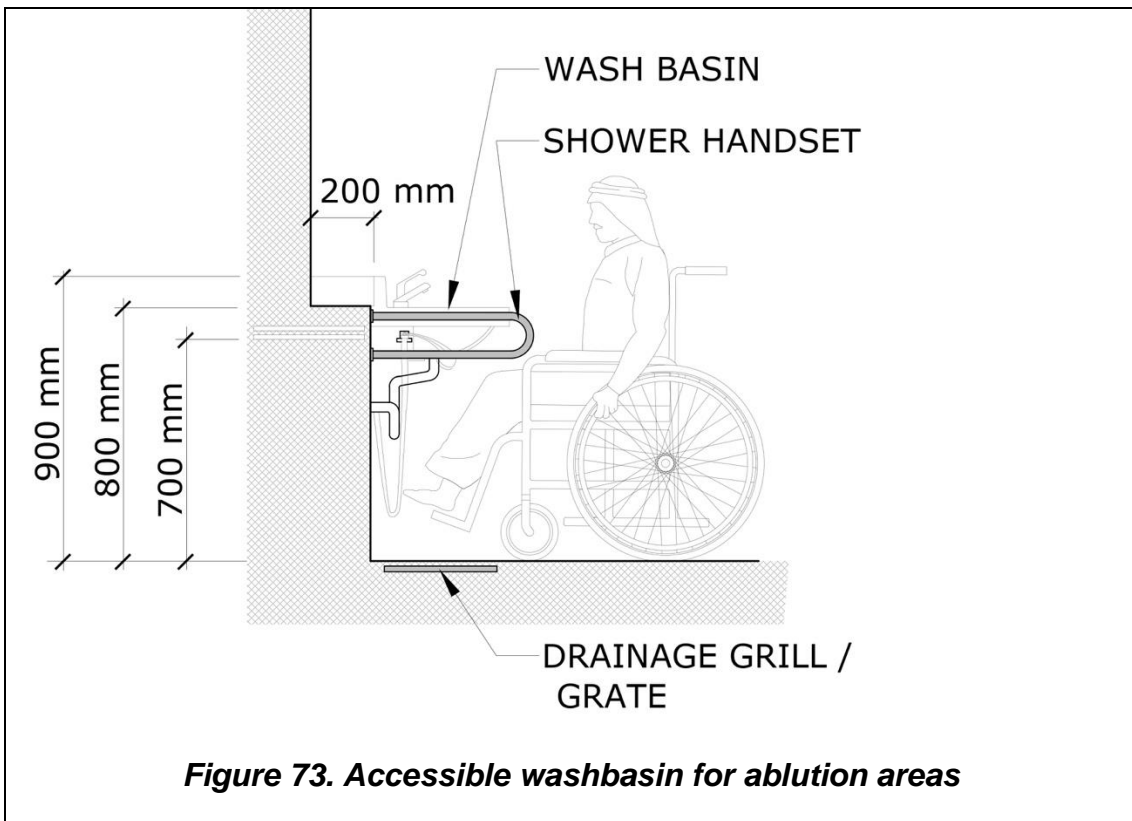
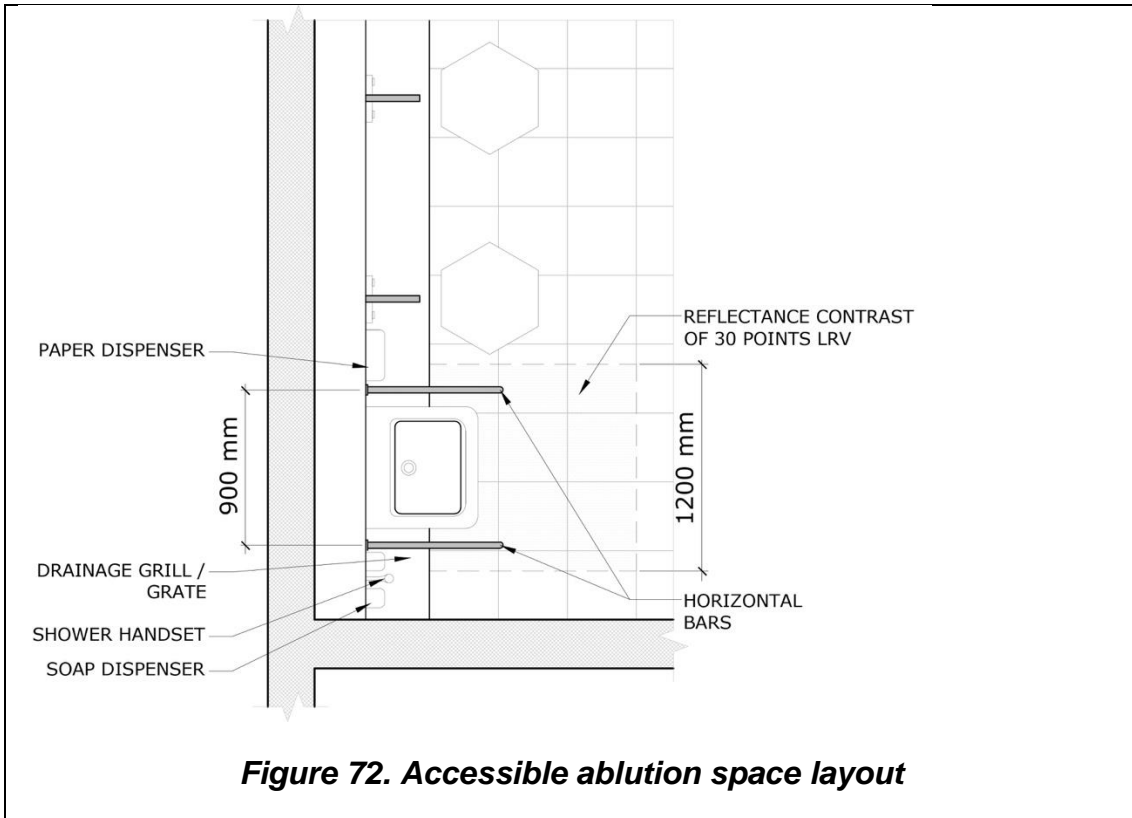
A minimum of 5%, but never less than one ablution unit shall be accessible and available in each ablution room.

Accessible ablution spaces shall be adjacent to an accessible route within ablution rooms. The ablution room featuring an accessible ablution spaces shall be connected through an accessible route to other spaces such as entrance, prayer room, toilets and emergency exit.

Electronic or sensor faucets shall be installed in ablution areas to facilitate its use and to reduce water waste.

In addition to the dimensions and characteristics of the accessible washbasins described in Section 23.5 of this code, ablution units shall meet the following requirements:

- a) It shall be linked to an accessible path and shall be the closest to the entrance door.
- b) Two horizontal grab bars, one in each side of the sink, shall be mounted at a height between 700 mm and 800 mm and have a support length, equal to the length of the sink.
- c) A bidet shower system, soap and paper dispensers shall be mounted near the sink. All accessories of toilets, including the bidet shower should be mounted at a height between 700 mm and 1200 mm.
- d) An approaching free space of 1200 mm width shall be provided. The pavement of this interaction space shall have a reflectance contrast with the surrounding pavement of at least 30 points LRV (Light Reflectance Value).

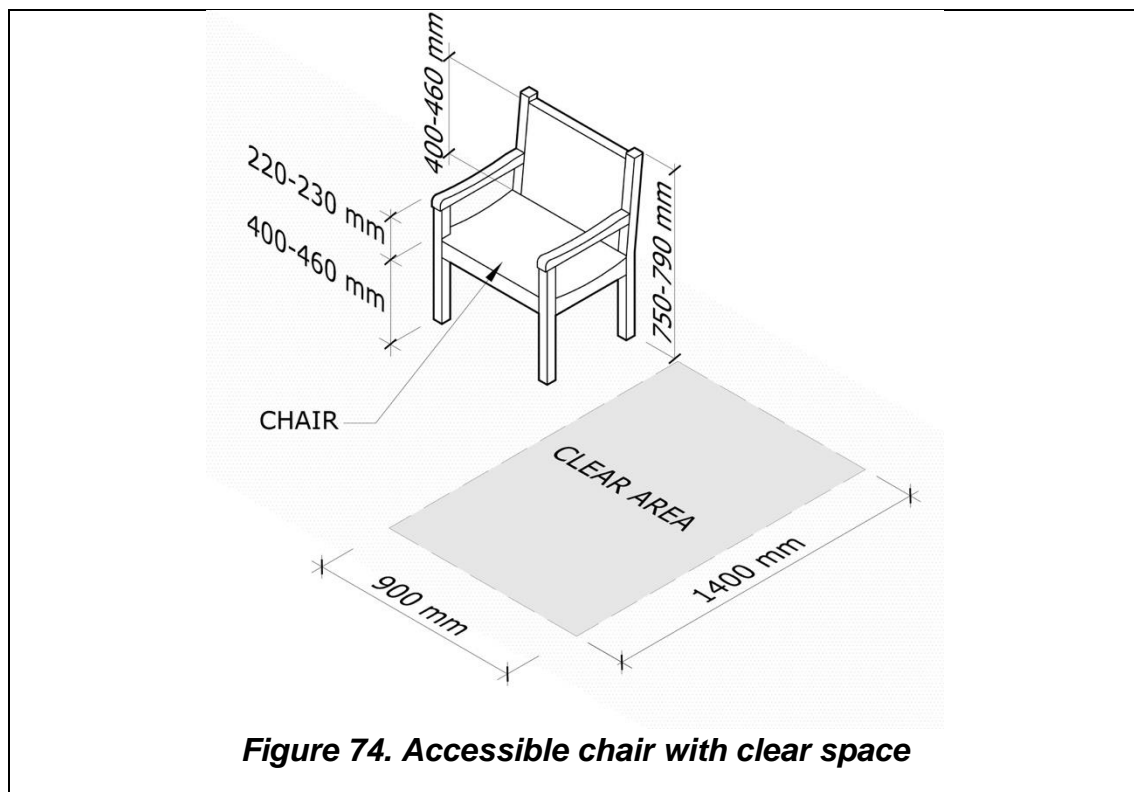


## 29 Furniture

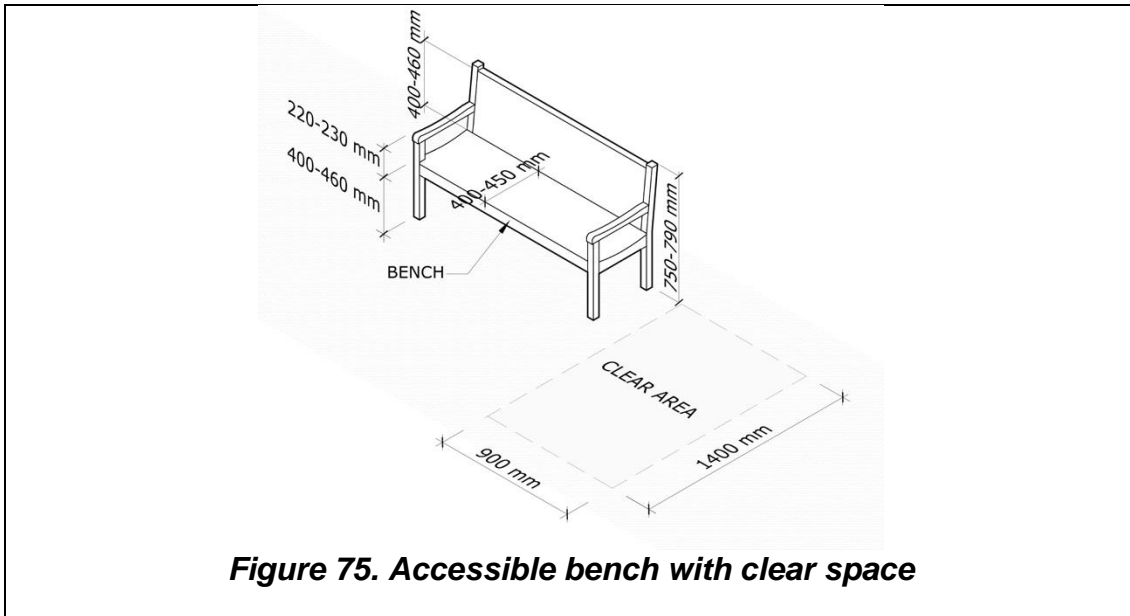
### 29.1 Accessible chairs and benches

Accessible chairs and benches must fulfil the following requirements:

- The seat height shall be 430 mm with a  $\pm 30$  mm tolerance.
- The seat depth shall be between 400 mm and 450 mm.
- It has a backrest and its height shall be between 400 mm and 460 mm.
- Some seats should have armrests.
- It has a transfer space on one side, out of the accessible route.
- It is recommended to provide furniture with standing support, in combination with benches of varied height.
- In urban spaces and parks benches shall be placed at least every 100 meters while in big buildings like shopping malls or airports benches or other seat types shall be provided every 50 meters.



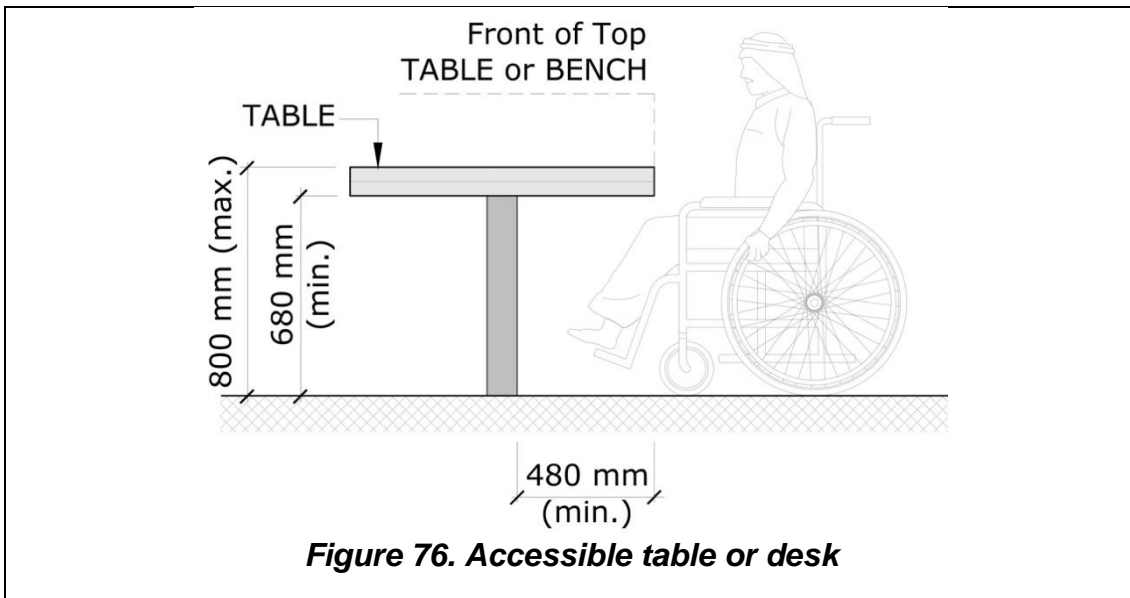
**Figure 74. Accessible chair with clear space**



## 29.2 Tables

Tables shall fulfil the following requirements:

- Tables shall not be higher than 800 mm with a minimum clear room for leg space of 680 mm high and 480 mm deep.
- Tables with integrated seats should be avoided.

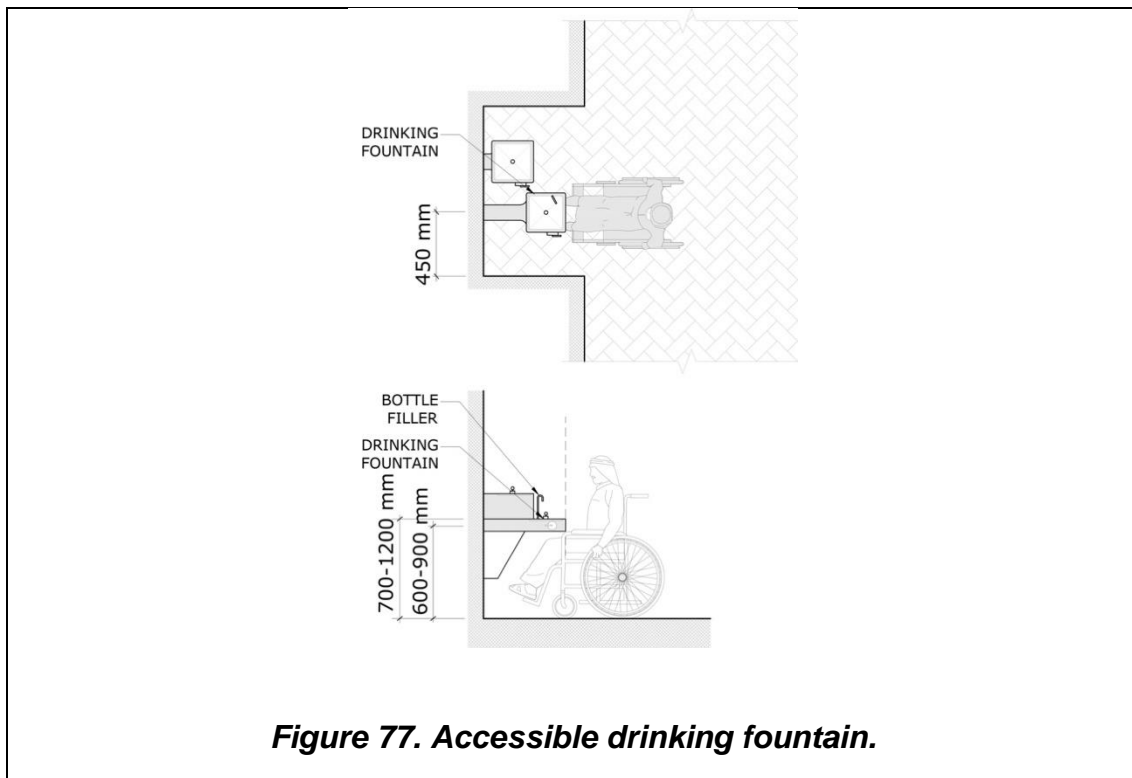




### 29.3 Drinking fountains

Drinking fountains must meet the following requirements:

- a) Two fountains with different heights shall be provided, one no higher than 915 mm above the floor for the accessible unit.
- b) Drinking fountains shall allow its use through frontal approach.
- c) If the push button is manual, it shall be at a height of between 700 mm and 1200 mm and have an accessible mechanism that is easy to operate.
- d) Water should be attainable at a height of between 600 mm and 850 mm  $\pm$  50 mm, and near to the approaching space. The design must prevent the user from getting wet during use.
- e) Drinking fountains should provide bottle fillers.
- f) Drinking fountains should be located in a niche where possible to ensure that it is not a protrusion hazard.
- g) Drinking fountains should be installed against a contrasting background to increase visibility.



**Figure 77. Accessible drinking fountain.**



## 29.4 Vending machines, ATMs, Auto-pay machines

Vending machines and ATMs should be accessible, according to the following criteria:

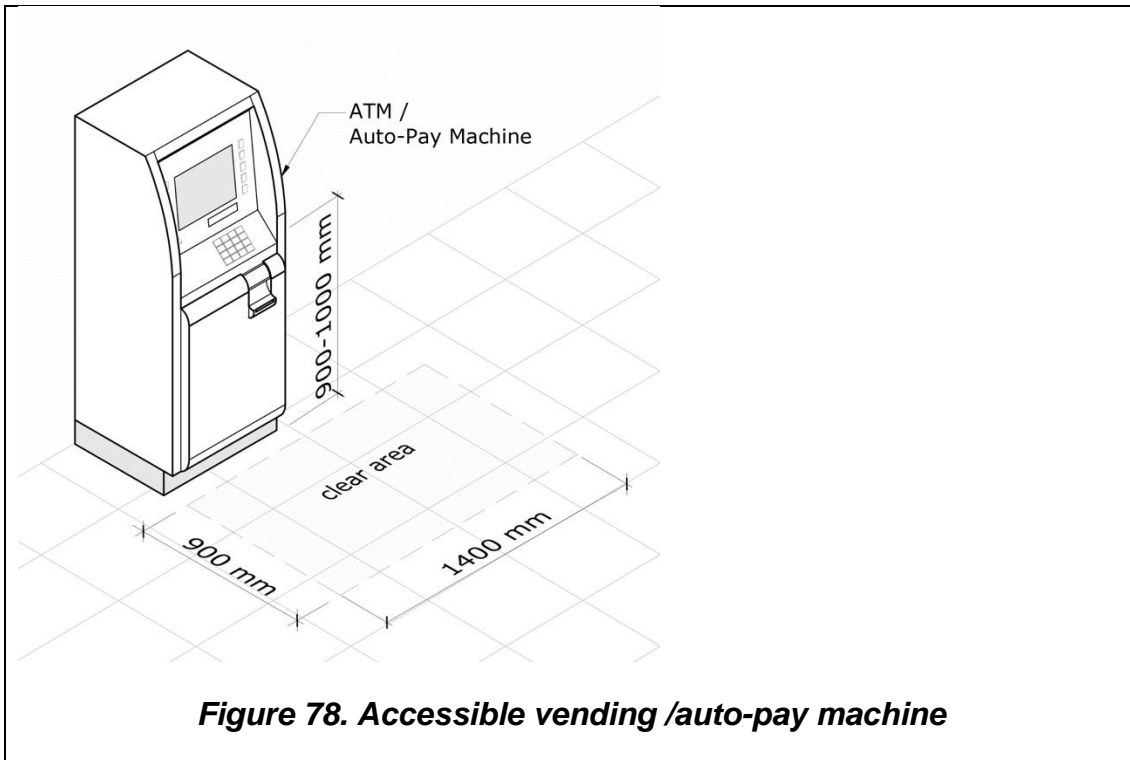
- a) There is at least one frontal or lateral clear interaction space ensuring privacy. The floor surface is smooth and non-slippery with a gradient of no more than 2%.
- b) If the vending machine protrudes from the vertical wall, edges must extend to the floor in all its plane projection.
- c) Screen and keyboard are visible from a point located 1000 mm above the floor. There are no reflections or glare.
- d) Direct illumination of the screen should to be avoided.
- e) All control buttons, as well as containers for withdrawal or deposit of products must be placed at a height between 400 mm and 1200 mm (preferred between 900 mm to 1000 mm) from the floor and must be separated at least 600 mm from any corner.
- f) Control buttons shall present high embossed text and Braille.
- g) Exterior vending machines should provide a canopy, extending a minimum of 1200mm from the machine's face and placed no less than 2200mm above ground.

When bank, identification or validation cards have to be used, the device must meet the following requirements:

- a) The card reader is located at a height between 800 mm and 1000 mm from the floor level and slot is bevelled.
- b) Should be colour contrasted with the background surface. Tactile symbols and graphics that represent the card inserting direction must be included.
- c) There should be an illuminated card above the slot, flashing when the card is inserted or withdrawn.
- d) It must have a visual and acoustic system to indicate validation of access to the service and to alert in case of forgetting the card or money withdrawn.
- e) It shall provide audio for all information.
- f) In the case of transport ticket vending machines or ATMs a CCTV Intercom shall be provided if personnel assistance is not available.

- g) The slots are wide and have a funnel effect that facilitates the insertion of coins or cards.

In all instances, there shall be sufficient dimensions to collect products issued or to retrieve the card.



## 30 Mosques and prayer rooms<sup>xii</sup>

Access to all areas of worship and other activity areas in the Mosque should be provided, assuming that people with disabilities may be participants, leaders, staff, or volunteers.

Mosques and prayer room shall fulfil the following requirements:

- a) An accessible route shall connect parking and outdoors pedestrian paths with the building entrance and interior spaces. An accessible entrance shall be provided.
- b) A clear area shall be provided at the entrance to prevent shoes from blocking the accessible route and door. This shall be complemented with a KEEP CLEAR mat if the clear entrance is not guaranteed.
- c) Seats shall be provided at entrances and at other locations where people are required to remove their shoes.
- d) Seating should also be provided within the prayer hall to accommodate people who cannot bend to pray.
- e) Provision should be made to address the potential lack of cleanliness of mobility device wheels where the route to the designated area crosses prayer hall carpeting.
- f) Any accessible route that may require crossing the prayer hall's carpeting shall have low pile carpeting.

## 31 Entertainment, conferences, lecture facilities

This section applies to audience seating, lecture theatres, seminar rooms, conference facilities, entertainment and sport venues, on either level or raked floors, which comprise audience seating.

When fixed seating is used, wheelchair spaces should be located in different parts of the seating layout to provide a range of choice of seating position.

When the room is on a level floor and seating is not fixed, all parts of the room shall be accessible to the wheelchair users.

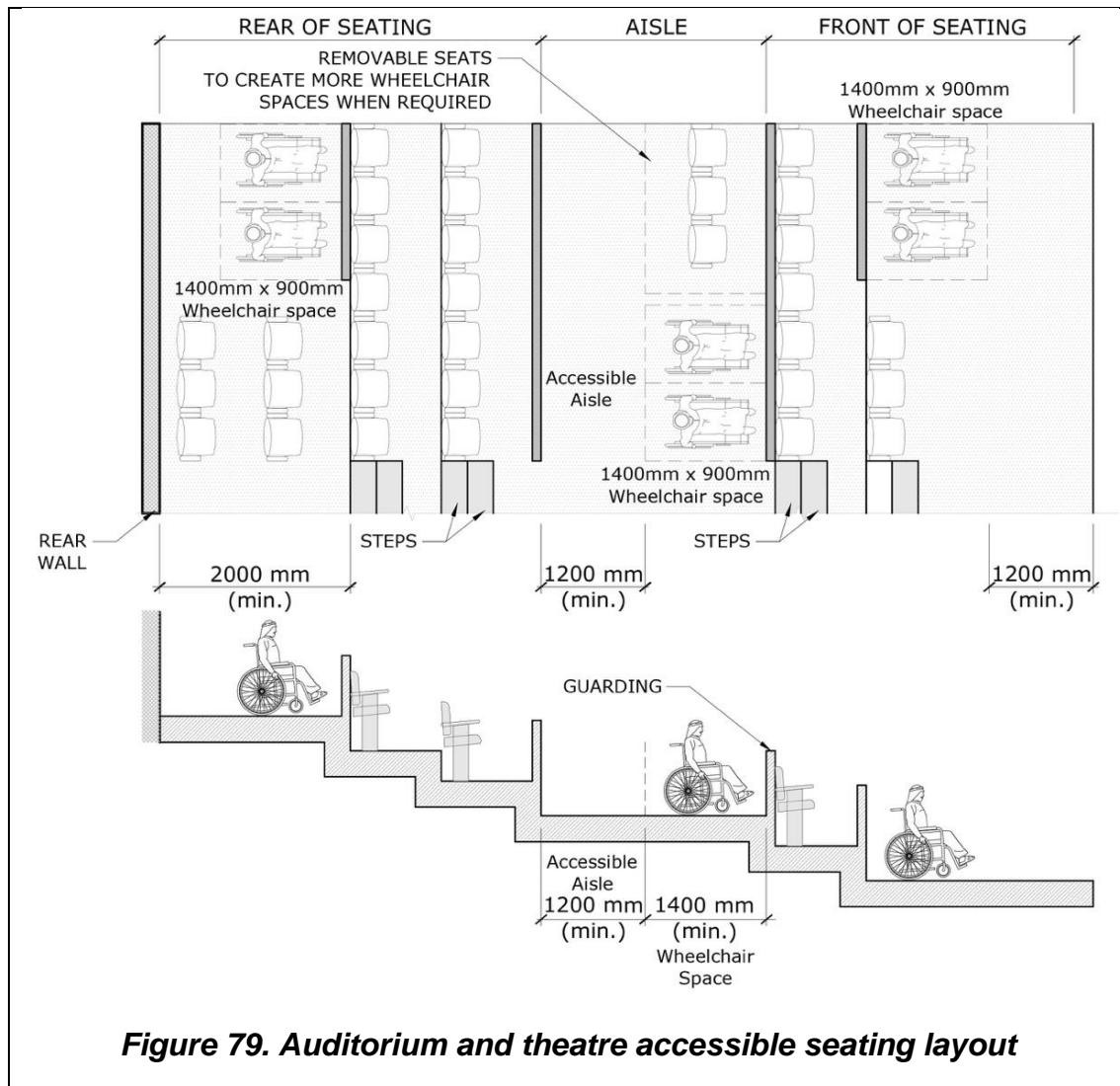
Unobstructed line of sight shall be equivalent for people using the accessible seating spaces.

### 31.1 Accessible seating spaces.

An auditorium seating space is considered accessible when it meets the following requirements:

- a) It is connected to an accessible route.
- b) Accessible seating can be provided with either permanent or removable seating.
- c) Level wheelchair spaces with dimensions shall be of at least 900 mm x 1400 mm if approached frontally and 900 mm x 1500 mm if the approach is lateral shall be provided.
- d) A level manoeuvring space of 1500 mm x 1500 mm must connect to each wheelchair space.
- e) It shall be marked with the international symbol of access (ISA), whether as permanent seating spaces or removable seating areas.
- f) Both the surface of wheelchair spaces and the clear manoeuvring space are level having a maximum longitudinal gradient of 1%.
- g) For facilities with fixed seats, designated wheelchair spaces shall be arranged into groups of 2. Each group of wheelchair spaces must have at least an equal number of fixed seats.
- h) If the designated wheelchair spaces include removable or foldable seats, the conversion process shall be quick and easy.
- i) Wheelchair spaces shall be provided in all auditorium-seating sections.

- j) The number of reserved wheelchair spaces shall comply: 1 reserved wheelchair space for every 50 seats or fraction thereof and beyond 500 seats, 1 more for every 100 seats or fraction thereof.
- k) In theatres, cinemas, conference rooms, auditoriums and all the facilities where people are expected to sit or wait, it is recommended that some seats should have a space for service animals near the owner.
- l) A space at the front of the hall or room where a sign language interpreter can be easily seen shall have an independent overhead light.
- m) A sufficient number of designated accessible seats for people with hearing impairments should be provided in front of the sign language interpreter.
- n) Aisle seats and its adjacent shall have foldable armrests.
- o) Accessible seating should not obstruct participants, or other members of the audience.



### 31.2 Podiums and backstage areas

Podiums with a level change should have ramps designed in accordance with Section 24.

Where podium is very high and there is no space for placing a ramp with adequate gradient, a lifting platform should be provided, in accordance with Section 23.4.

An accessible route should be provided between the backstage area and dressing rooms, storage areas, toilets, showers and exit routes.

### 31.3 Box office counters

Box office counters should be accessible to wheelchair users, conforming to recommendations for front desks in Section 13.3.

### 31.4 Study places

Study places shall provide access, circulations and furniture in accordance with the minimum width and height provided in this Code.

### 31.5 Hearing enhancement systems

A hearing enhancement system (such as an induction loop, FM or infrared) is required to communicate with hard of hearing persons and shall be provided in the following types of buildings:

- meeting rooms,
- auditoriums,
- service counters,
- theatres
- lecture/concert halls.

A hearing enhancement system enables sound signals to be transmitted to persons using hearing aids without interference from background noise or excessive reverberation level.

Hearing enhancement systems that operate using induction loops, infrared and radio frequency are commonly used to provide enhanced level of sound.

Where hearing enhancement systems are provided for persons with hearing impairment, the international symbol of access for hearing loss shall be provided.

Hearing enhancement systems shall be compatible with language translation systems.

A sign should be posted indicating that the enhancement system is available.

## 32 Accessible hotel rooms

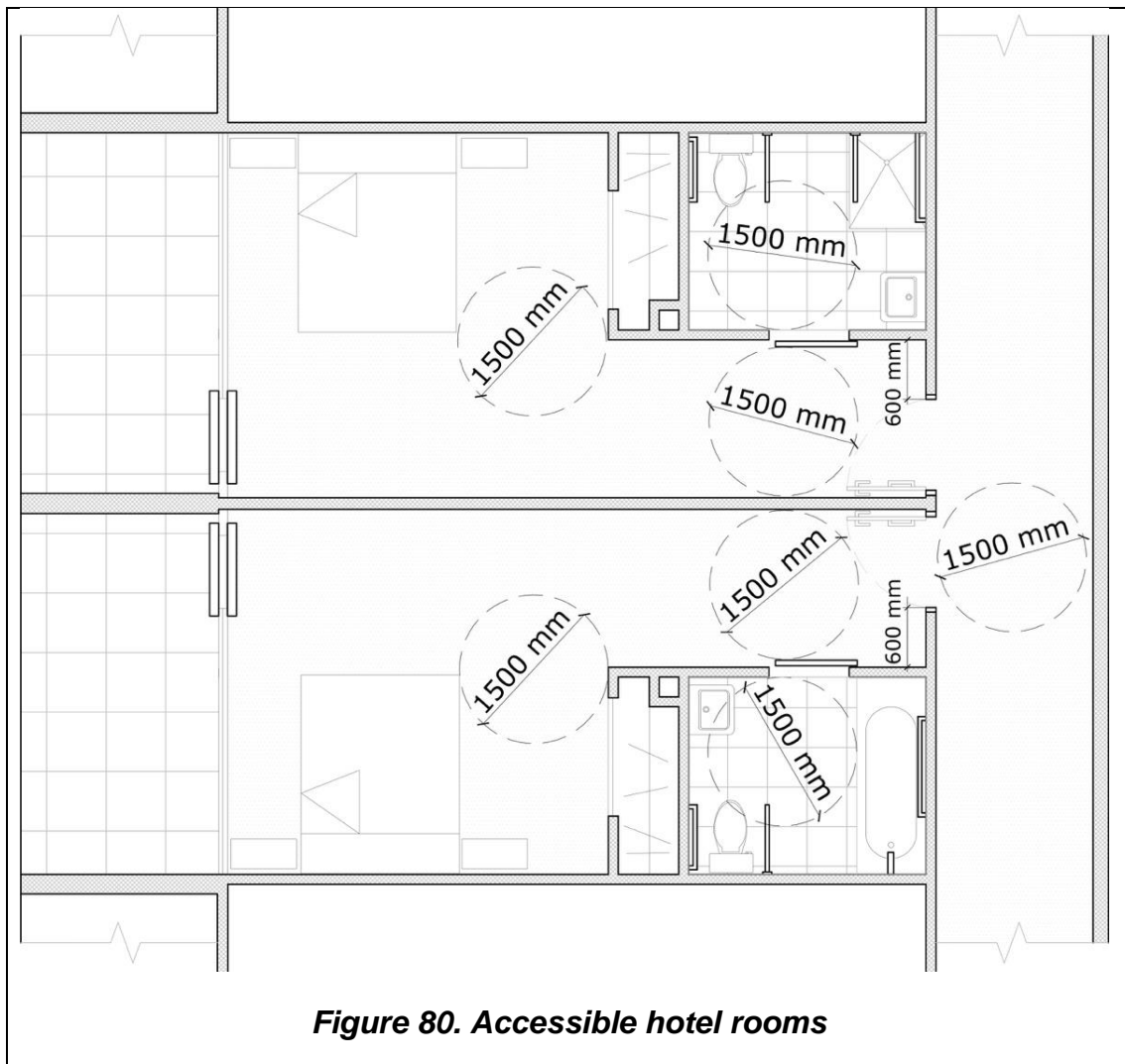
Every hotel shall provide access to all the services and facilities it offers, complying with all Sections in this Code.

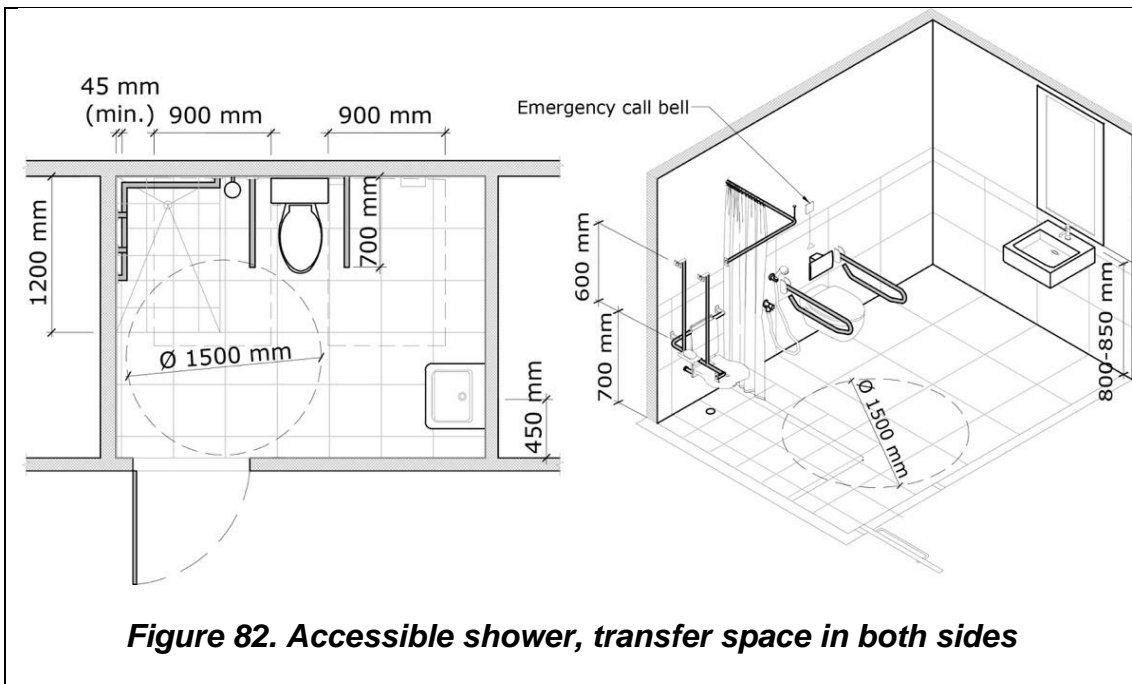
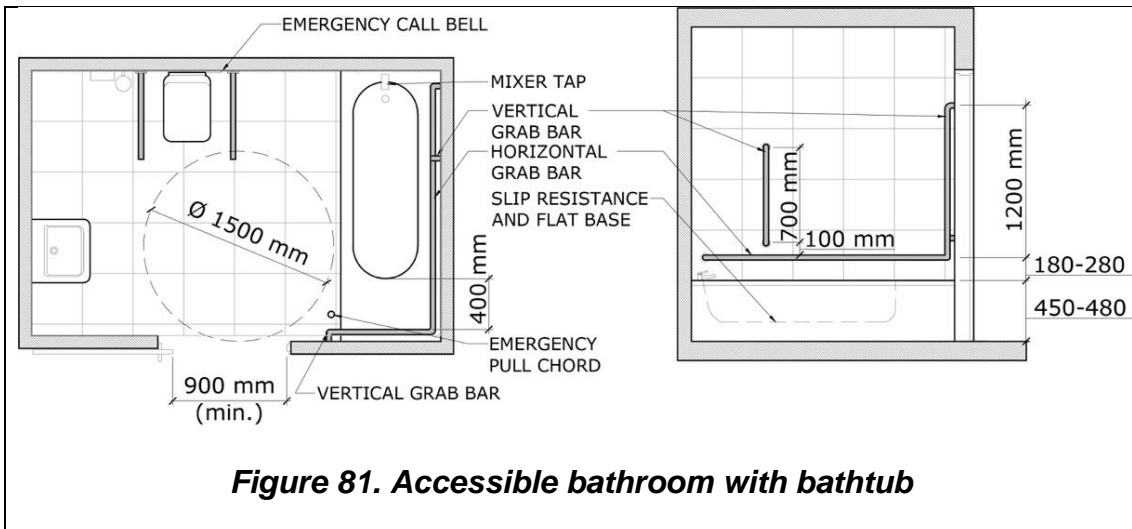
Hotel rooms shall fulfil the following requirements:

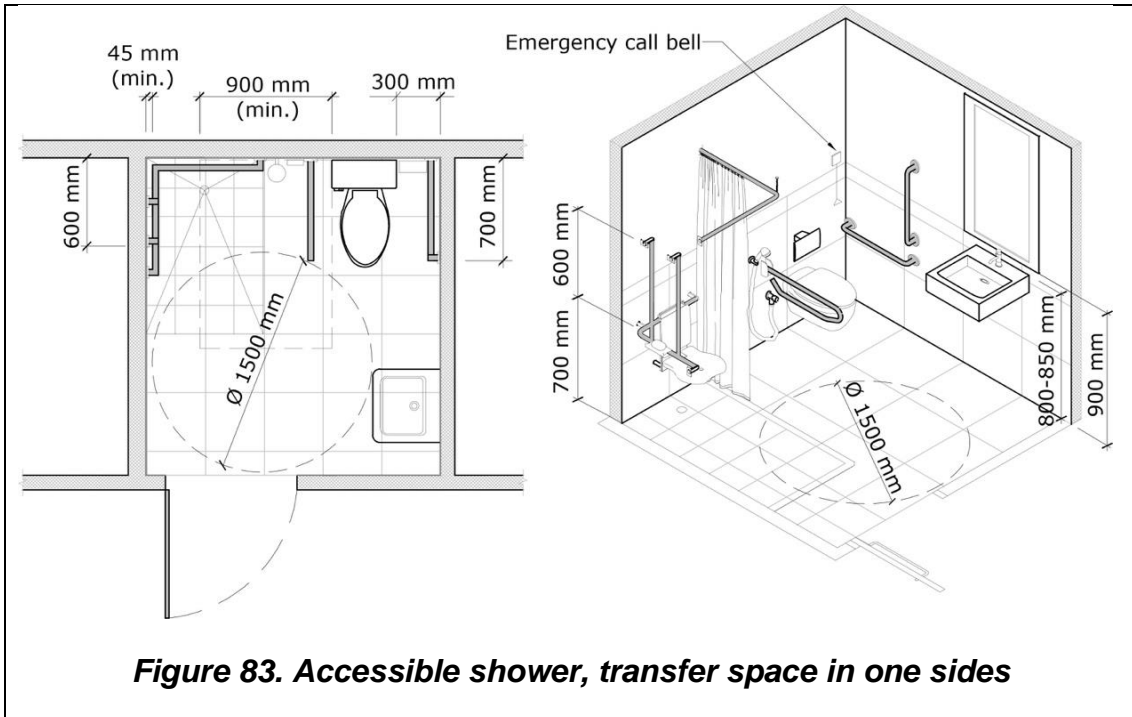
- a) There should be an accessible route leading to the accessible rooms and from them to other hotel premises open to all guests.
- b) At least 10% of hotel rooms shall be accessible, or at least one of each type of room offered, such as: standard bedrooms, suites, penthouse, etc.
- c) Accessible rooms should include a mix of single, twin, family or double room formats, depending on the hotel size and category.
- d) A clear route shall be provided to the bed with a minimum clear space of 1500 x 1500 mm beside the bed.
- e) The bed in the accessible rooms shall have a maximum height of 500 mm.
- f) The accessible rooms shall be provided with acoustic and visual fire alarms in the living areas and toilet, as well as a doorbell with sound and visual notification.
- g) A minimum of illumination of 200 lux shall be provided in the living area and toilet.
- h) Lightning should have two-way switching in order to facility operating the lights form the room entrance or from the bed.
- i) Controls shall be placed at a height between 700 mm to 1200 mm except for the ones to be used from the bed. Electric outlets shall be provided at a height between 400 – 1000 mm.
- j) Accessible rooms should be able to interconnect with adjacent rooms, via accessible doors.
- k) The bedroom's door locks should use an electronic operating system, for example card-operated or proximity card,
- l) An accessible toilet bowl with grab bars shall be provided in compliance with this Code.
- m) Half of the accessible hotel rooms shall provide roll-in showers while the other half shall provide bathtubs following the requirements of the drawings below. In both cases an alarm string shall be provided.



- n) A dressing mirror where the user can see his or her reflexion from 250 mm to 2000 mm shall be provided.
- o) Shelves and drawers shall be provided between 700mm to 1200 mm from the floor, and at least one section of the clothes hanger should be placed at 1100 mm from the floor.
- p) A viewing device should be provided in the door at a height between 800 mm – 1000 mm.
- q) There shall be no change for entering the bathroom, including the washbasin, toilet and shower sections.







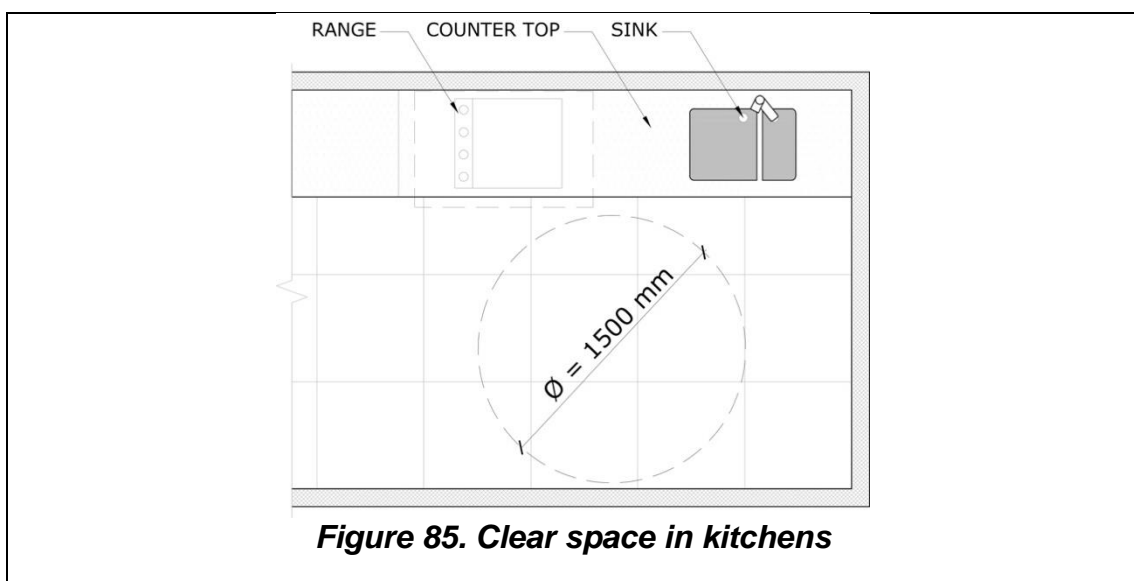
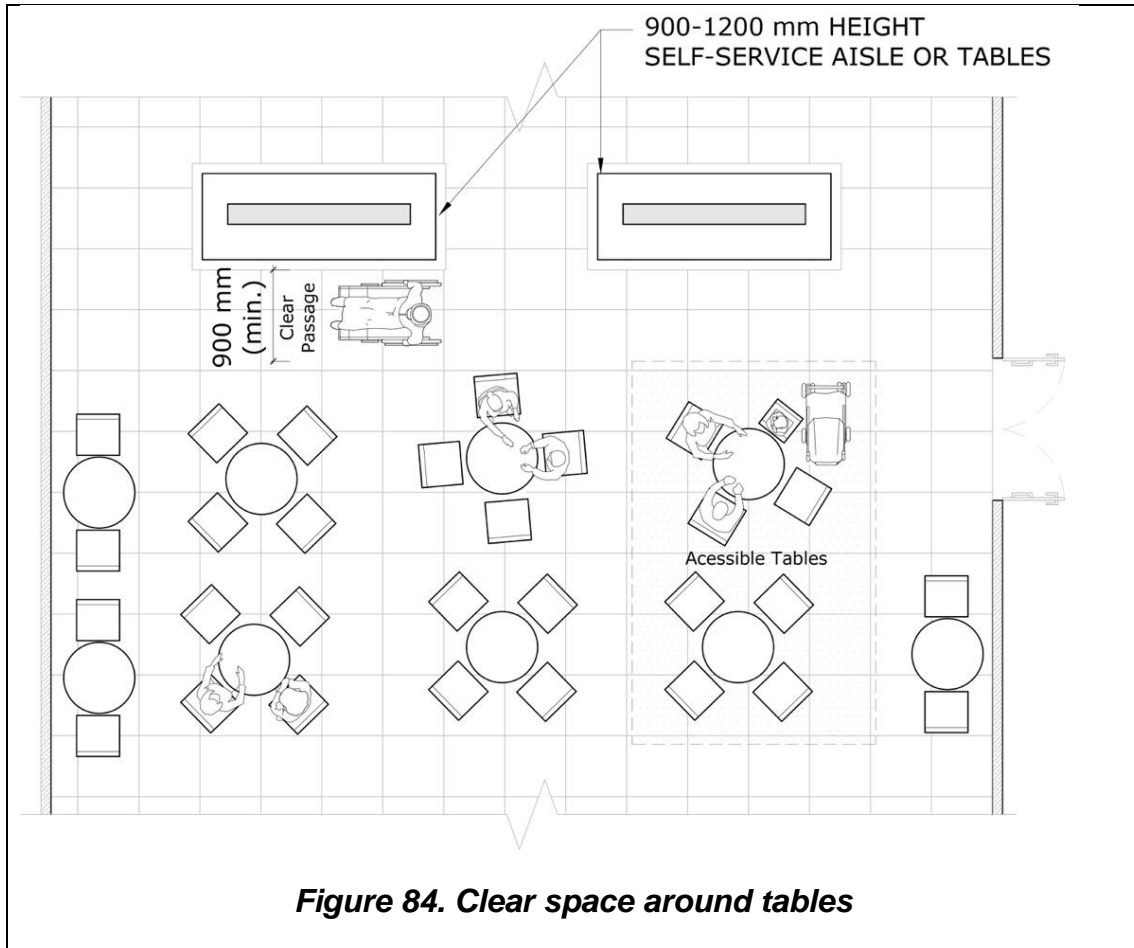
### 33 Accessible dining rooms

Restaurant, cafes, lounges and self-service dining services shall fulfil the following requirements:

- a) An accessible route shall be provided to reach at least half of the dining areas.
- b) Changes in level on the seating area shall be served by ramps, according to the specifications of this Code.
- c) At least 10% of the tables shall comply with the dimensional criteria for tables described in the Furniture section of this Code and shall be connected to an accessible route. At least a 900 mm of clear width shall be provided to access these tables.
- d) In facilities with fixed seats to the tables, at least 10% of the seats shall be movable.
- e) If fixed tables are used, chairs should be movable.
- f) Tables and chairs should provide visual contrast with their surrounding environment.
- g) Illumination of at least 100 lux shall be provided in at least 10% of the dining room.
- h) Sound reduction materials should be incorporated into dining rooms.
- i) The floors, and walls shall be made of a smooth & washable material that is easily cleaned and non-absorbent.
- j) Where self-service food displays or shelves are used, all food, condiments and ramplery shall be located between 900 mm and 1200 mm from the floor.
- k) If queuing lines are used for self-service they should be at least 1100mm wide and marked with queuing rails. Rails should have colour contrast with the surrounding elements or surfaces.
- l) A clear passage of a minimum of 900 mm should be provided to all food service areas, condiments and utensils.
- m) Space for children strollers and mobility devices shall be provided.

If kitchen facilities or self-service amenities are provided in buildings, they should be accessible. Kitchens or kitchenettes shall provide enough Manoeuvring spaces, as shown in Figure 85.

Kitchens or kitchenettes should provide work surfaces or appliances at different levels. Work surfaces shall incorporate clear knee space

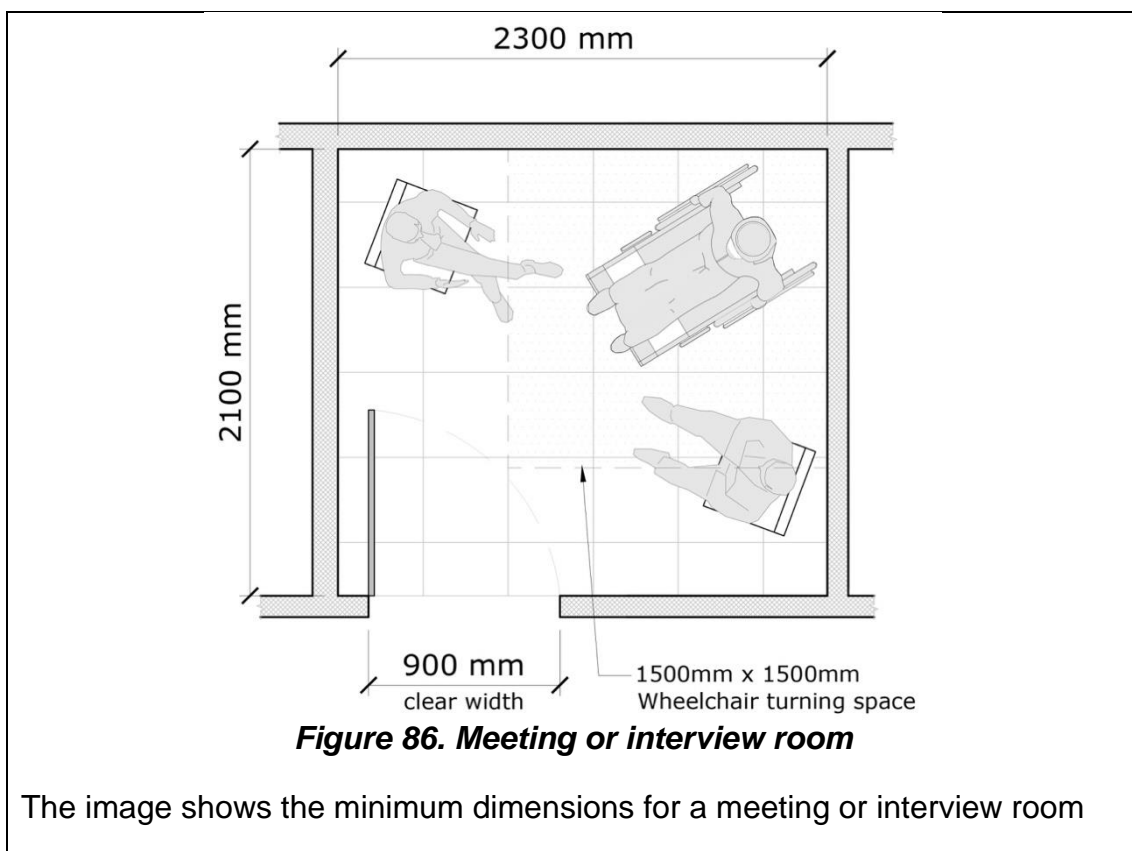


## 34 Accessible workplaces and commercial buildings

Parking and the approaching route to workplaces and commercial buildings shall conform to the specifications of this Code.

Entrances, internal horizontal and vertical circulations, furniture and toilets shall conform to the specifications of this code.

Where meeting or interview rooms are provided, the minimum dimensions shall conform to specifications in Figure 85.



All counters, checkouts and service points shall be accessible according to the specifications of Sections 13 and 27.

### 34.1 Accessible smoking areas

If outdoor smoking areas are provided, they should be served by an accessible route and have enough space to accommodate a wheelchair user. A minimum dimension of 2400 x 2400 is recommended.

## 35 Shops, supermarkets, shopping malls

Shops, supermarkets and shopping malls shall follow this Code's requirements for being accessible to customers and staff employed in all areas.

Attention should be given to provide adequate aisles widths, headroom and wayfinding.

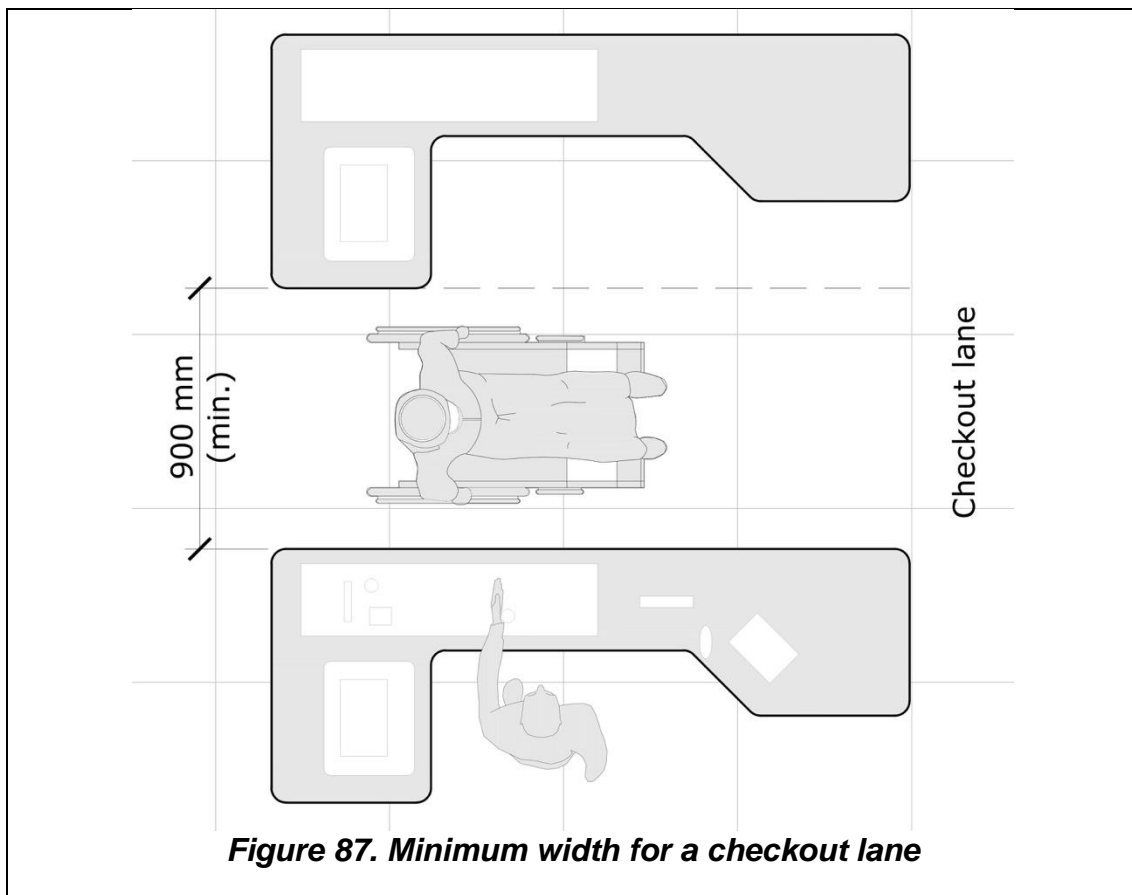
Parking for customers and staff shall conform to specifications of Section 12.

Shelves and displays should allow people to see and select products at a range of heights.

Clothes rails should be located no higher 1200mm above the finished floor.

All counters, checkouts and service points shall be accessible according to the specifications of Sections 15.3, providing a dual-height section.

Figure 86 shows the minimum width for an accessible checkout lane. At least one accessible checkout lane shall be provided in supermarkets or any other large shop where multiple checkout lanes are provided.





### 35.1 Accessible fitting rooms

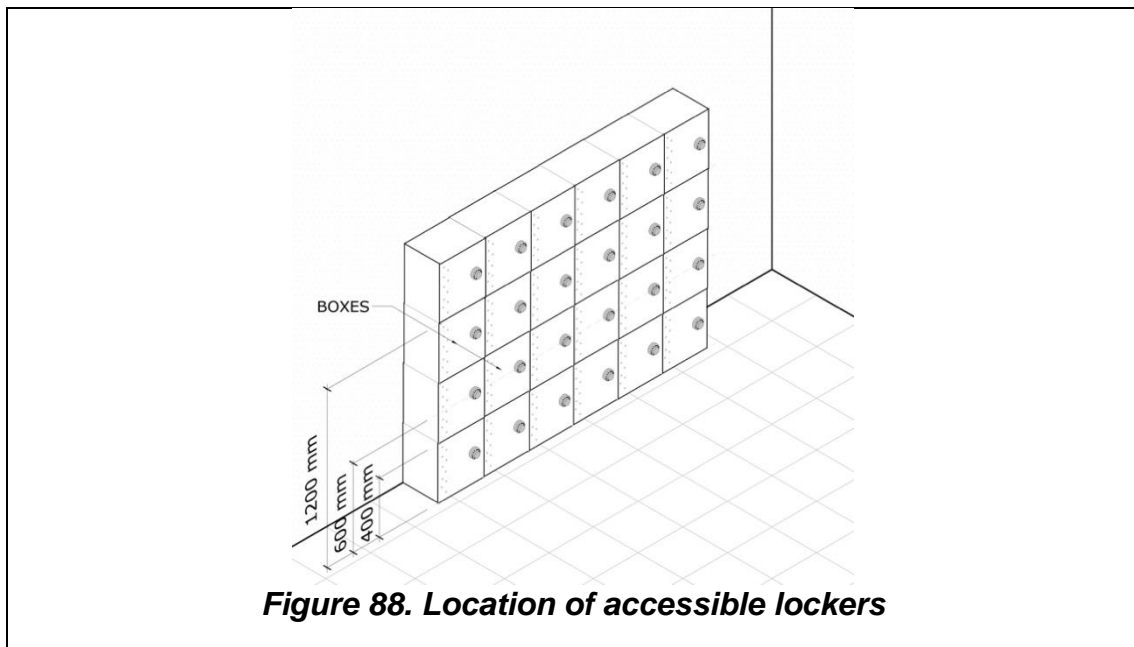
Shops that provide changing rooms shall provide at least one accessible fitting room for each fitting rooms cluster, with the following specifications:

- The accessible fitting room shall have minimum dimensions of 2300 mm x 2500 mm.
- The interior corridors in the fitting room cluster should have a minimum width of 900 mm.
- Shall provide a padded fold-down seat and a full-body mirror.
- The same level of accessibility shall be provided for both genders.
- Clothes hangers shall be located at two heights, one at a maximum height of 1700mm and one at a maximum height of 1200mm above floor level.

### 35.2 Lockers

20% of shelves, boxes or lockers shall be within reaching distance for a wheelchair user or people with short stature, between 600 mm and 1200 mm above the floor.

Lockers numbers should be well contrasted and tactile. If benches are provided, they should be moveable.





## 36 Accessible changing rooms

Sport premises or any other facility that provide changing rooms shall provide at least one accessible changing room for each changing room cluster, with the following specifications:

- a) The accessible changing room shall have minimum dimensions of 2000 mm x 2000 mm.
- b) The interior corridors in the changing room cluster should have a minimum width of 900 mm. In direction changes, there is a clear manoeuvring turning space of 1500 mm diameter outside of any opening door space.
- c) If there are lockers, the provisions for storage facilities shall be respected.
- d) Benches shall not obstruct access to lockers or the accessible changing room.
- e) The approaching space for lockers, benches and furniture should have a minimum width of 865 mm and should connect to the accessible path of travel.
- f) If there are showers, at least one of every ten shall meet the criteria for accessible showers as described in this Code.
- g) If there are toilets, 1 of every 10 shall be accessible, according to the specifications of this Code.
- h) The same level of accessibility shall be provided for both genders.

## 37 Healthcare and welfare buildings

The following types of new buildings shall follow this Code's requirements:

- a) Hospitals
- b) Health centres
- c) Doctors' and dentists' surgeries
- d) Opticians
- e) Day centre,
- f) Special needs centres

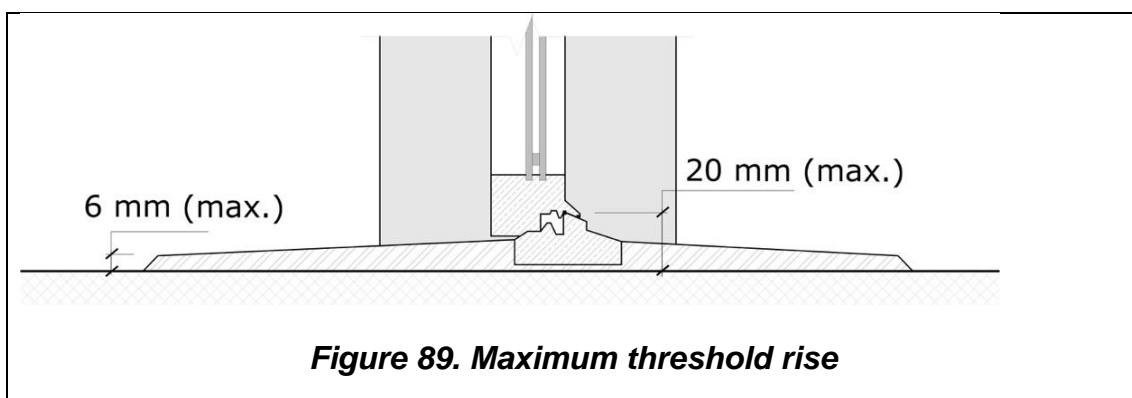
Parking, approach to the building, as well as internal spaces, services and equipment common to most buildings, shall conform to the specifications of this Code's Sections.

## 38 Balconies

Terraces, verandas and balconies linked to accessible rooms or spaces shall be accessible to all people including people with mobility limitations.

To ensure this requirement, they shall fulfil the following characteristics:

- a) The door to the balcony shall provide at least an obstacle free width of 900 mm.
- b) The balcony exterior and interior levels shall be the same.
- c) Wherever it is possible the balcony doors shall be installed flush with the floor level. When a raised threshold is necessary it shall have a maximum height of 20 mm and be bevelled down to a height of 10 mm chamfered.
- d) The minimum dimensions of the balcony shall be 1500 mm x 1500 mm.
- e) Walking surfaces shall be slip resistant.



## 39 Requirements for parks, beaches, natural spaces, outdoors areas

Benches or places to sit in parks shall be designed according to the provision of this Code.

Information about the nearest public accessible toilets and interest points within the park or beach shall be installed at least in every path intersection, following the parameters for information panels described in the Wayfinding Section of this Code.

Public accessible toilets shall be installed near the accessible path.

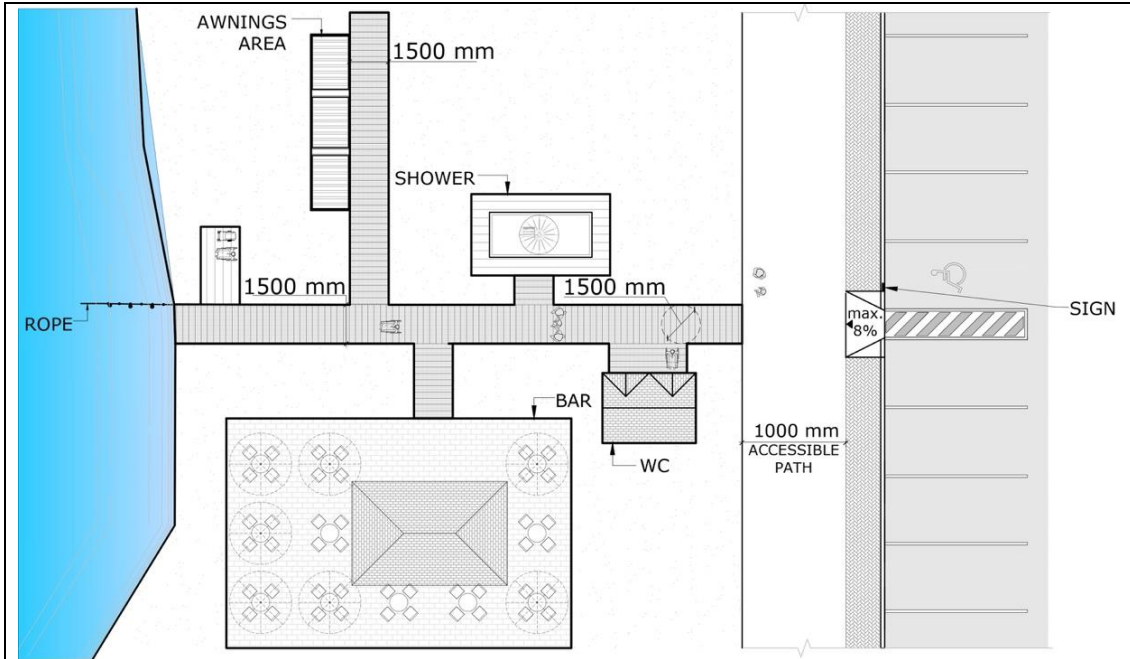
Supplementary paths can be used at beaches and natural landscapes where walking would be difficult.

A temporary path is considered accessible when it meets the following technical requirements:

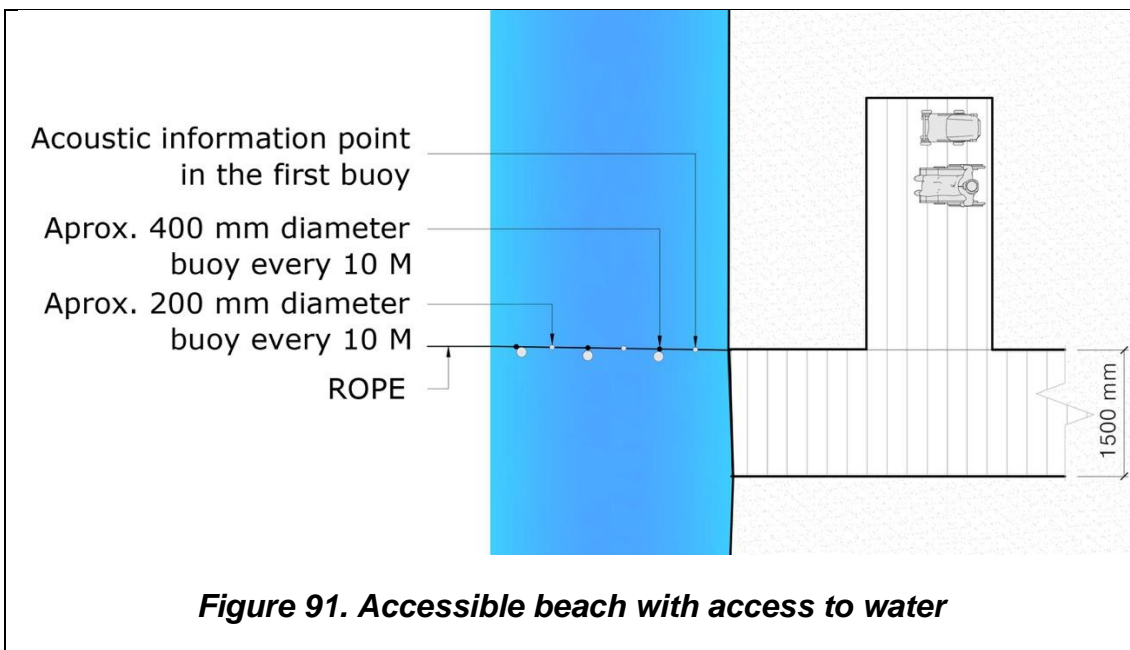
- a) It has a width of 1500 mm free of obstacles.
- b) Whenever the natural slope of the terrain allows it, a path's running gradient shall not be greater than 5% and the cross-fall gradients shall not be greater than 2%.
- c) It is constructed of material that has a heat transmission coefficient that allows walking barefoot over them.
- d) Supplementary paths shall reach as close as possible to the water's edge.
- e) There should be at least one accessible unit of each utility, such as toilets, lounges, beach coffees and restaurants, showers, changing rooms, furniture, emergency services among others. These utilities should be installed as close as possible to each other and shall be connected by an accessible path. Access to them shall also be via an accessible path from the beach's access and from the accessible path to the water's edge.

### 39.1 Accessible beaches

In the case of lakes and sea, there shall be a rope to help users in the accessible point of access into the water. This rope remains floating and its length is adapted to the specific conditions of each swimming area.



**Figure 90. Accessible beach layout**

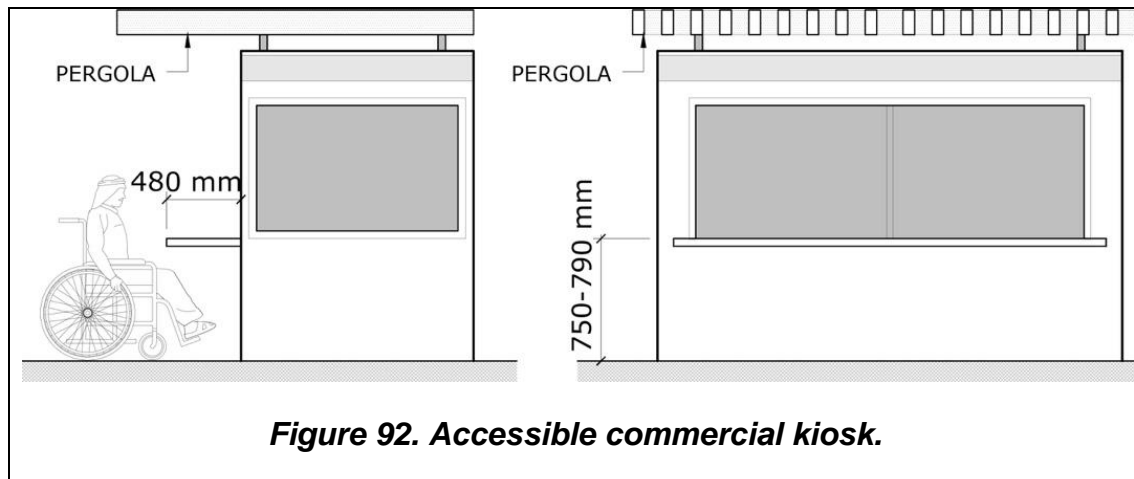


**Figure 91. Accessible beach with access to water**

### 39.2 Accessible outdoor kiosks

Commercial kiosks must meet the following:

- a) It shall have a customer counter with a lateral or frontal interaction space.
- b) Outdoors kiosks shall have a pergola in the front side.
- c) This interaction space shall be linked to an accessible path.
- d) It shall be equipped with a hearing enhancement system and a post indicating such.
- e) All controls shall be at a maximum height of 1200 mm.
- f) All information shall be provided in audio and visual formats.
- g) Visual information shall be well contrasted and in a minimum of 14 pt.



### 39.3 Swimming pools

Swimming pools and other bathing pools for public either for indoors or outdoors use, shall have at least one accessible means of entering the water and an accessible path linking the pool with the facilities and the common areas.

Accessible means of entering the water are illustrated in Figures 93 and 94. They can be either a ramp if there swimming pool is big enough to allow the placement of a ramp with a slope according to the requirements of this Code, or a chair lift.

For private use swimming pools like in condominiums the accessible provisions shall be followed if a tenant requires it.

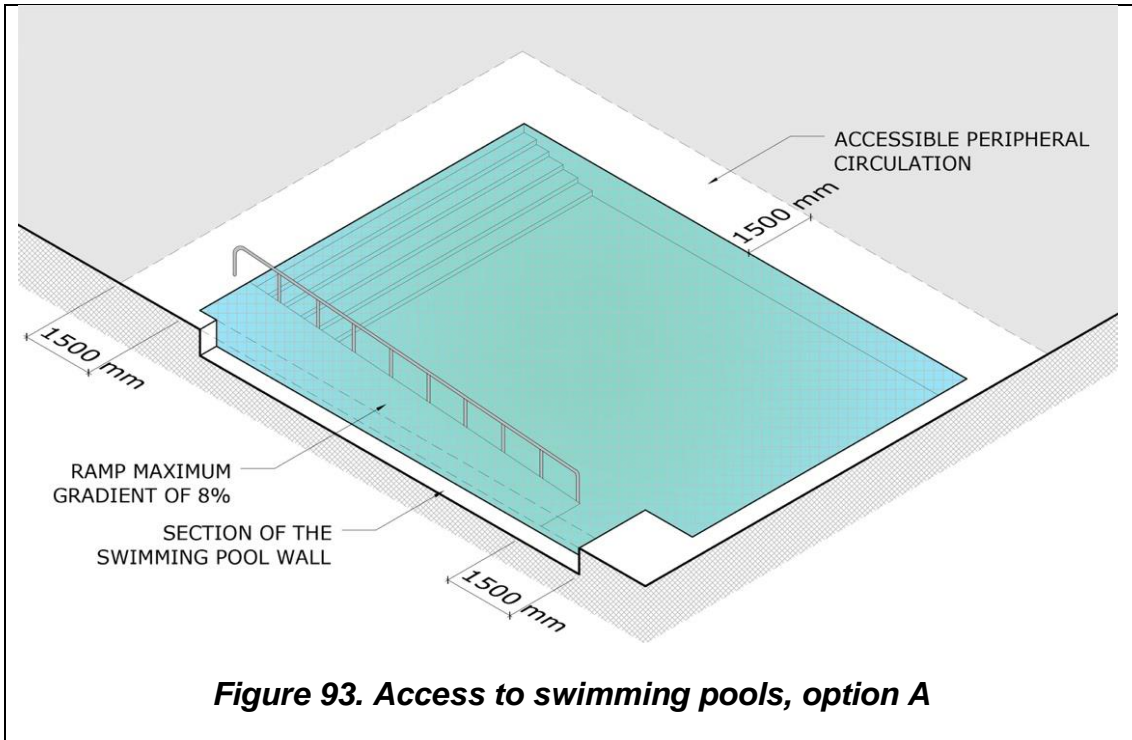
The floor surface of the swimming pool areas shall comply with the Section 6.3

If there is information messaging, the facility shall provide screens and loudspeakers, and the information shall be provided in two alternate formats simultaneously. The technical criteria of the messages displayed are described in the Wayfinding Section of this Code.

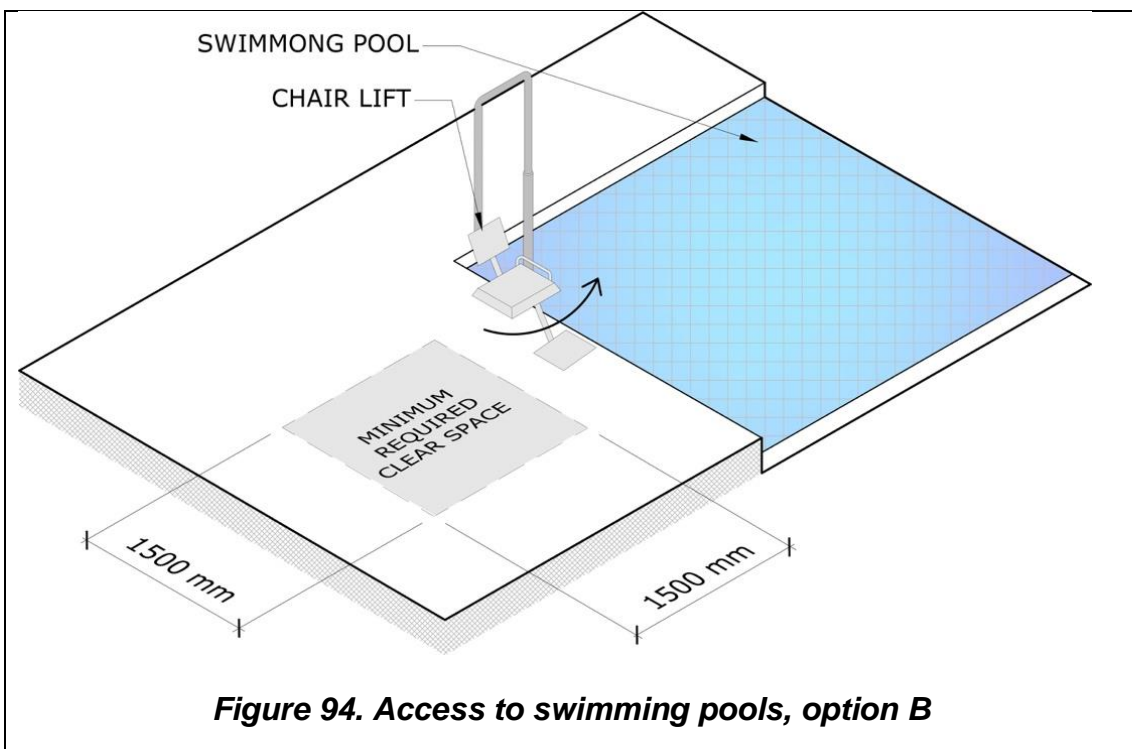
If an accessible path for the entrance to the pool cannot be provided, a ramp or an assisted elevation chair or hoist shall be implemented.

Other requirements:

- a) Safety ladder
- b) Underwater illumination if night use is foreseen.
- c) Depth scale following the signs requirements presented in the Wayfinding Section of this Code.
- d) It should be connected to an accessible change room for each gender.



**Figure 93. Access to swimming pools, option A**

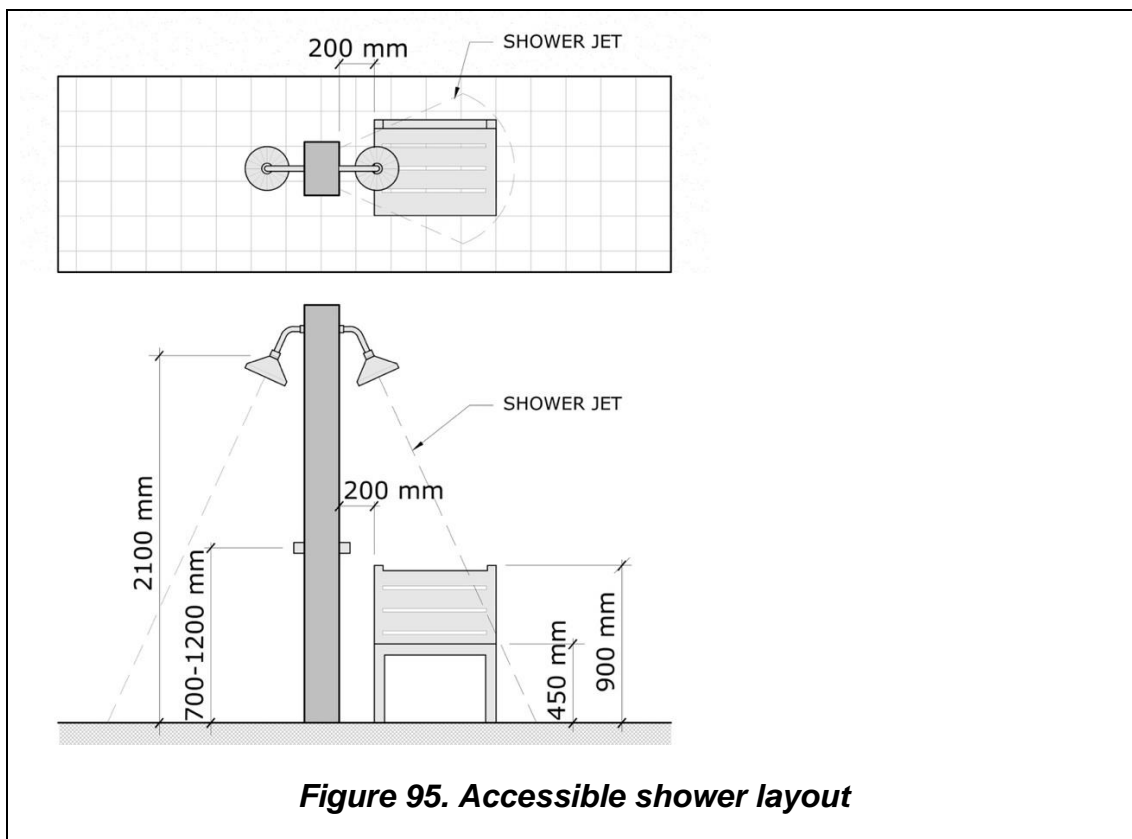


**Figure 94. Access to swimming pools, option B**

### 39.4 Outdoor showers

Outdoor accessible showers shall be provided at accessible beaches and swimming pools. These shall be linked via an accessible path and interaction space. They shall be at least 1800 mm in width and shall be provided with a bench without arms.

Shower controls shall be a button placed between 700 mm and 1200 mm and be possible to be activated with one hand.



### 39.5 Picnic areas

In facilities where picnic areas are provided with tables, 10% of the tables or at least one picnic table shall be accessible, according to the Section 29.2 Tables, of this Code, allowing approaching by a wheelchair user.

Tables with fixed seats or benches in all their sides are not considered accessible.

Accessible picnic tables shall be serviced by an accessible route, connecting to entrance, parking, toilets or any other amenities provided to any user.



## 40 Controls and operating mechanisms

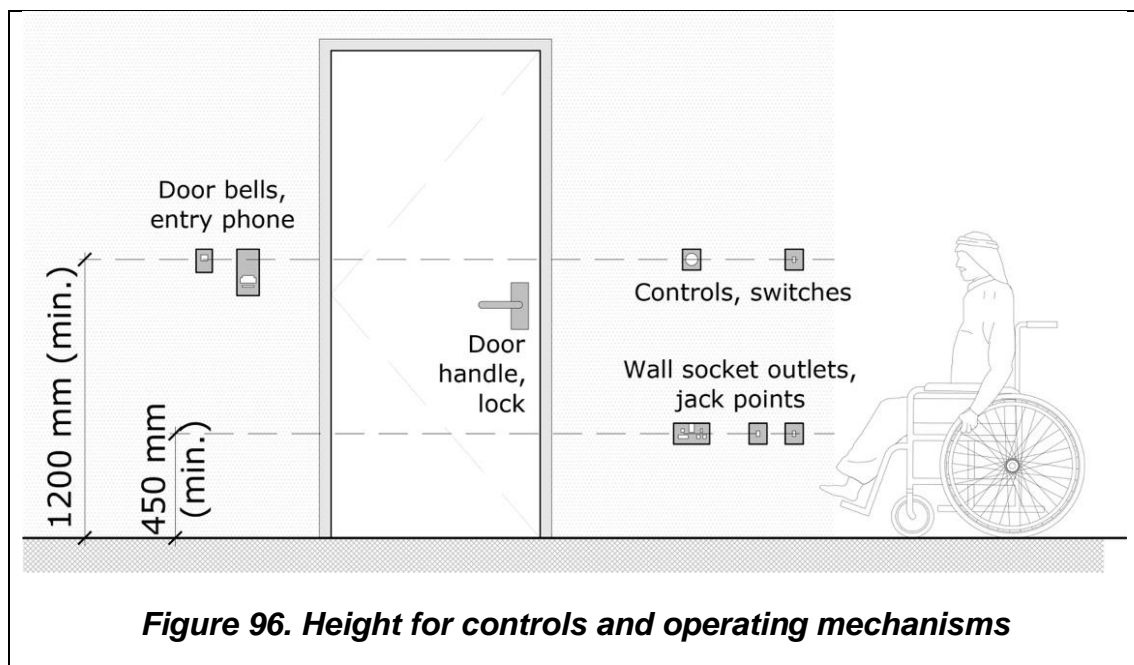
Clear floor space of at least 900 mm by 1400 mm should be provided at controls or operating mechanisms.

Controls and operating mechanisms include but are not limited to:

- Door handle and locks
- Levels or mixer tapes
- Activation devices, vending machines, auto-pay machines
- Window openers and locks
- Electrical sockets outlets and switches
- Security access systems.

Specifications:

- Located adjacent to an accessible route and a clear floors space with a minimum width of 900 mm.
- Located at a height of between 450 mm to 1200 mm from the floor level.
- Operable with one hand, of a type that doesn't require tight grasping, pinching or twisting of the wrist.
- Operable with a force of 22N or less.



## 40.1 Card access

Shall be located on the latch edge of the door, either on the door face or on the adjacent wall.

The activation control or card reader shall be positioned within 200 mm of the door frame, at a height of between 800 mm and 1200 mm from the finished floor level.

Be colour contrasted with the background.

Include tactile graphic symbols and have both audible and visual signals to indicate that access has been granted.

## 40.2 Keypads

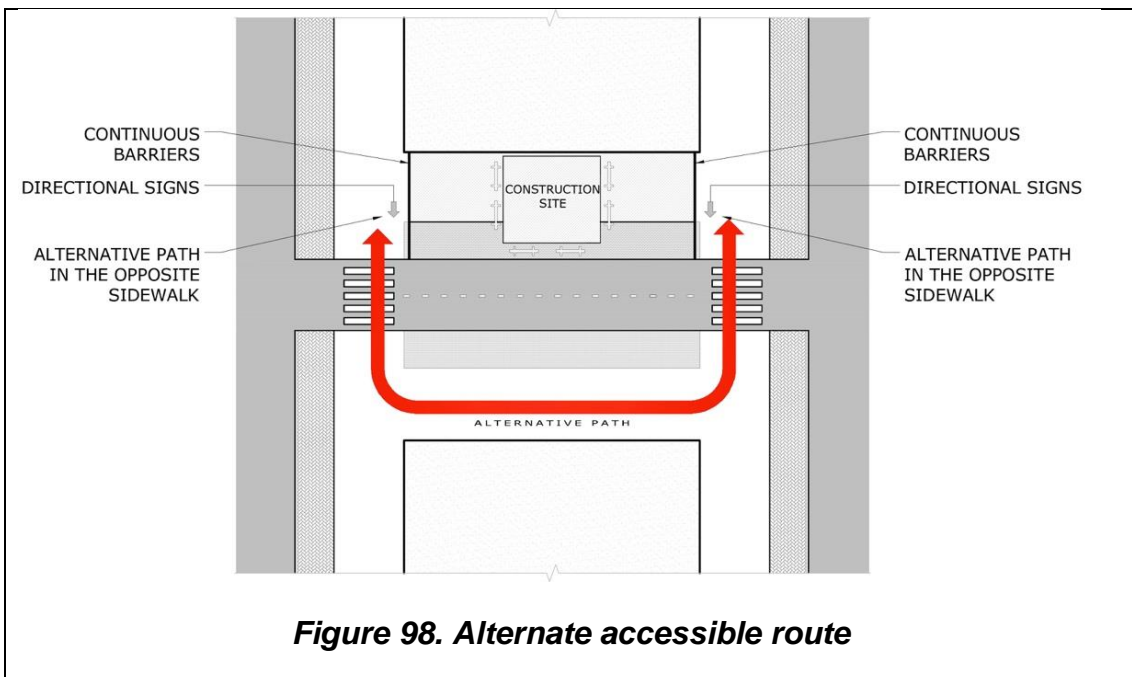
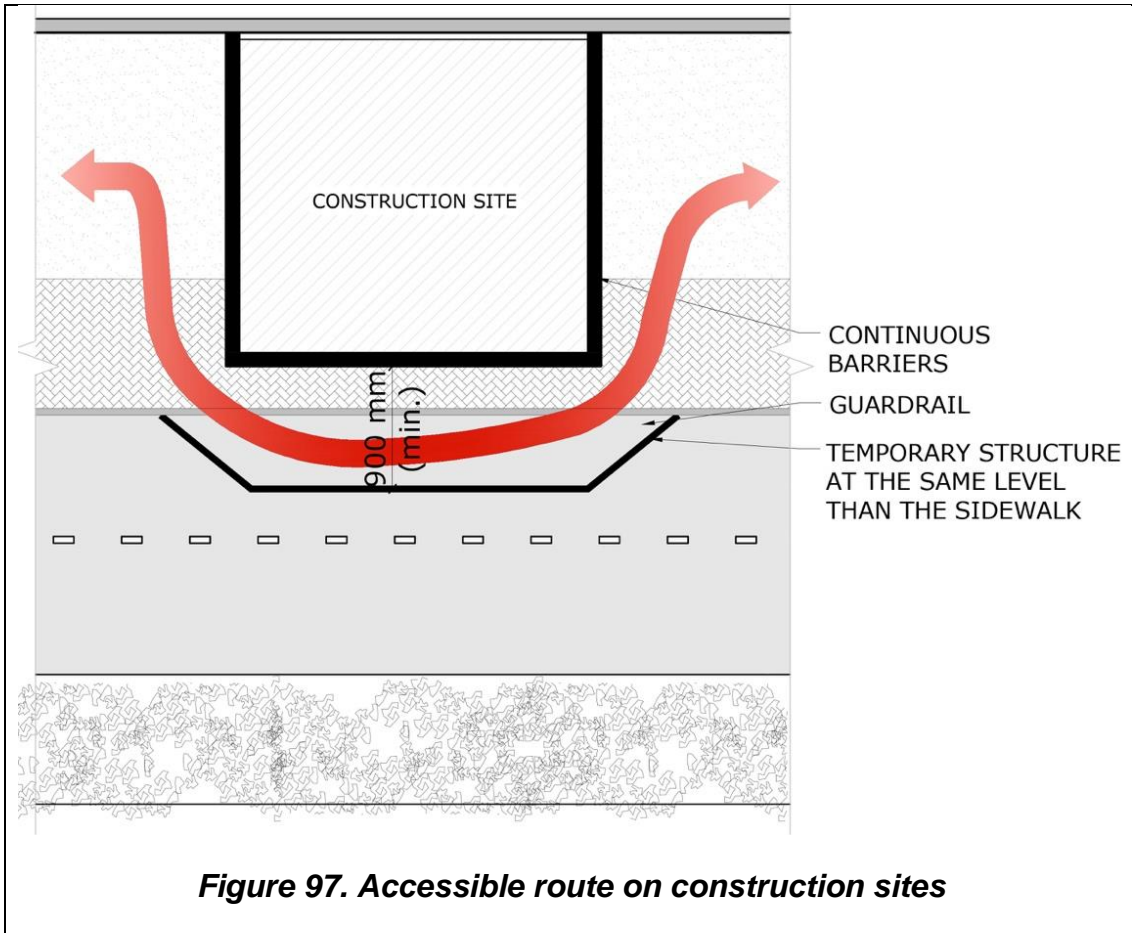
A keypad shall:

- a) Be located at a height of between 800 mm and 1200 mm from the finished floor level.
- b) Be colour contrasted with the background.
- c) Have characters that are colour contrasted with the keys
- d) If numeric, be telephone type and have a raised dot on the number 5 that is  $07 \pm 0.1$ mm high, has a base 1.5mm in diameter.
- e) Have both audible and visual signals to indicate that access has been granted.

## 41 Pedestrian protection on construction works<sup>xiii</sup>

Trenches and construction work in public spaces, along pedestrian routes, shall fulfil the following conditions:

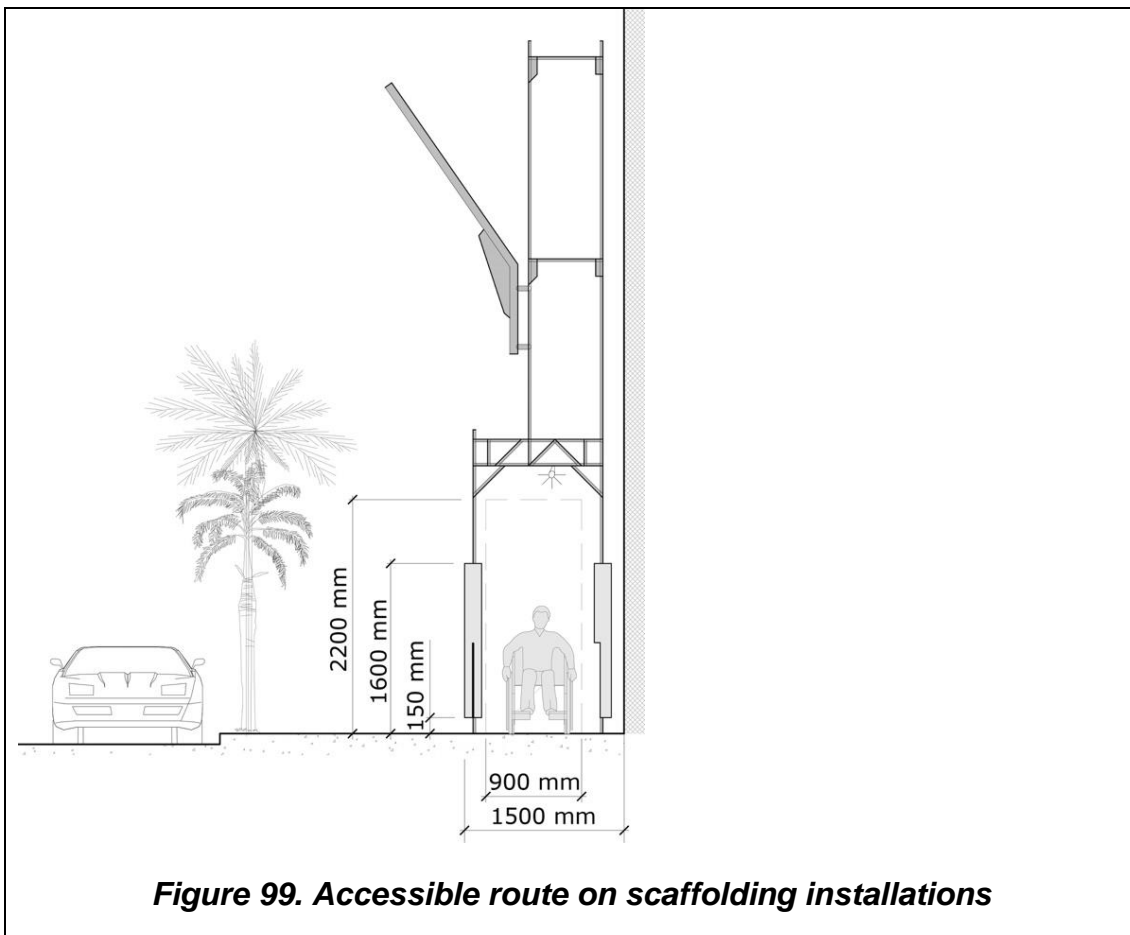
- a) They shall be protected with stable, solid fencing and protection elements that prevent people falling into the trenches or construction site.
- b) All protective and warning elements shall have a detectable edge at a maximum height of 680 mm, for people with low vision to easily detect them easily.
- c) Warning lights and audible signals shall be provided to alert people of the construction site at night.
- d) An alternative path in the opposite sidewalk or an alternative route shall be considered, according to the construction site conditions.
- e) Accessible routes shall not be obstructed during operations of loading, unloading and material supply.
- f) Where material and debris generated by the construction have to be stored on the road, it shall be clearly marked and protected to ensure that it does not constitute a danger for pedestrians or vehicles.
- g) In the case of pedestrians walking over trenches protected with metal plates that shall have a minimum width of 900 mm, provide a stable surface and be level with the surrounding surface, with guardrails on both sides. Guardrails must follow the requirements of this Code.



## 41.1 Scaffolding

Scaffolding for pedestrian protection shall comply with the following criteria:

- The temporary or alternative path shall have a minimum width of 900 mm and headroom of 2200 mm, free of obstacles.
- Where there are changes in direction, the minimum clear dimensions shall be 1500 mm x 1500 mm.
- When the width of the sidewalk does not allow the installation of scaffolding, an additional walking surface adjacent to the sidewalk shall be provided.
- If the road or sidewalk does not allow the provision of scaffolding, an alternative path shall be provided.



## 42 Wayfinding<sup>xiv</sup>

### 42.1 General

Wayfinding encompasses all the ways in which people orient themselves in physical space and navigate from place to place. When there is a well-designed wayfinding system, people shall be able to understand their environment. This provides users with a sense of control and reduces anxiety, fear and stress.

The built environment should be designed, constructed and managed to facilitate orientation. Orientation means to find one's way, to avoid obstacles which could cause hazards, and to know when one has reached its destination.

In complex sites, visual, audible and tactile information should be provided to assist in orientation and wayfinding.

Orientation can be facilitated by a carefully planned layout, differences in acoustics, surface material, light and colour. Illumination, visual contrast and tactile information shall be provided at key decision points.

It is important to provide wayfinding information in a variety of different formats as visual, auditory, olfactory and physically. All people use different forms of information gathering to find their way to their destination but this is especially important for people with disabilities.

From the user perspective, the wayfinding process involves four stages:

Table 5. Wayfinding Process

Wayfinding process	
<b>1 Orientation</b>	Is the attempt to determine one's own location in a concrete space in relation to the chosen destination
<b>2 Route decision</b>	Is the selection of a course of direction to the destination
<b>3 Route monitoring</b>	Is checking to make sure that the selected route is heading towards to the destination.
<b>4 Destination recognition</b>	Is when the destination is recognized

Communicate the environment's identity clearly and consistently through the design of graphic elements to increase the users' recognition and sense of confidence in the signage system during navigation.

## 42.2 Signage

Visual, acoustic and tactile references shall be used to guide a person to avoid risks and to reduce confusion.

Signs with texts and symbols, visual references, tactile information like high-embossed characters or Braille text are the elements that shall be used.

Signage information on a sign should be kept to the minimum and organised with hierarchy, without duplication. Complex information should be broken down, beginning with general information and moving towards more specific information.

The elements to be used to assist a person in the wayfinding process shall guarantee that:

Every person, even a person with low vision, can easily identify in which part of the city or building they are in at a concrete moment.

All buildings shall display the name of the building in the facade and a provide a directory in the hall, listing the companies or services contained in the facility.

In buildings, orientation signs to the exit, toilet and other services shall be present at any corridor intersection at every 30 meters.

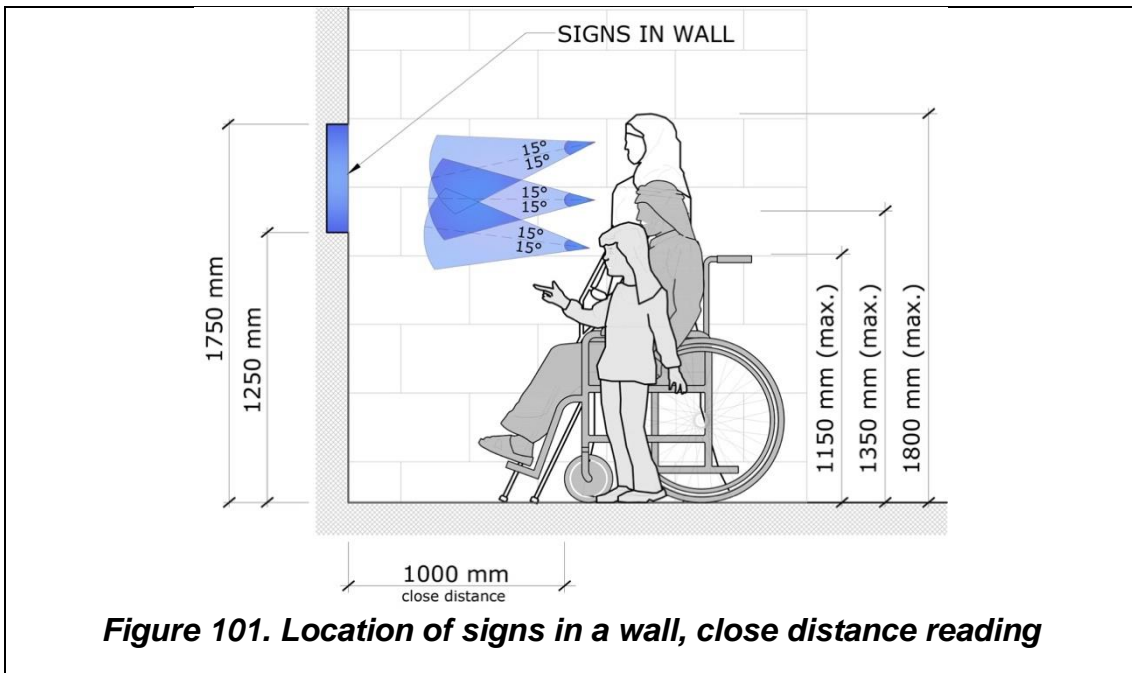
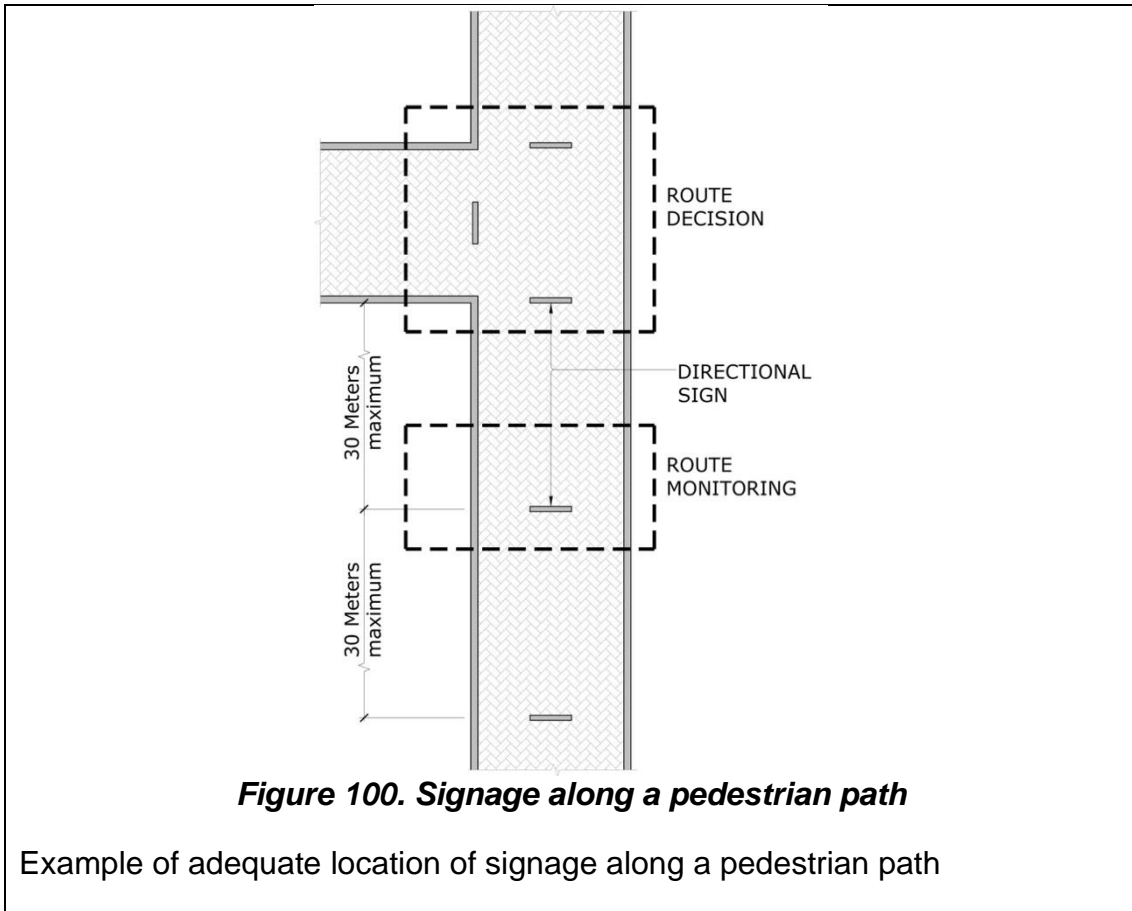
All door frames shall provide information about the service provided in the space.

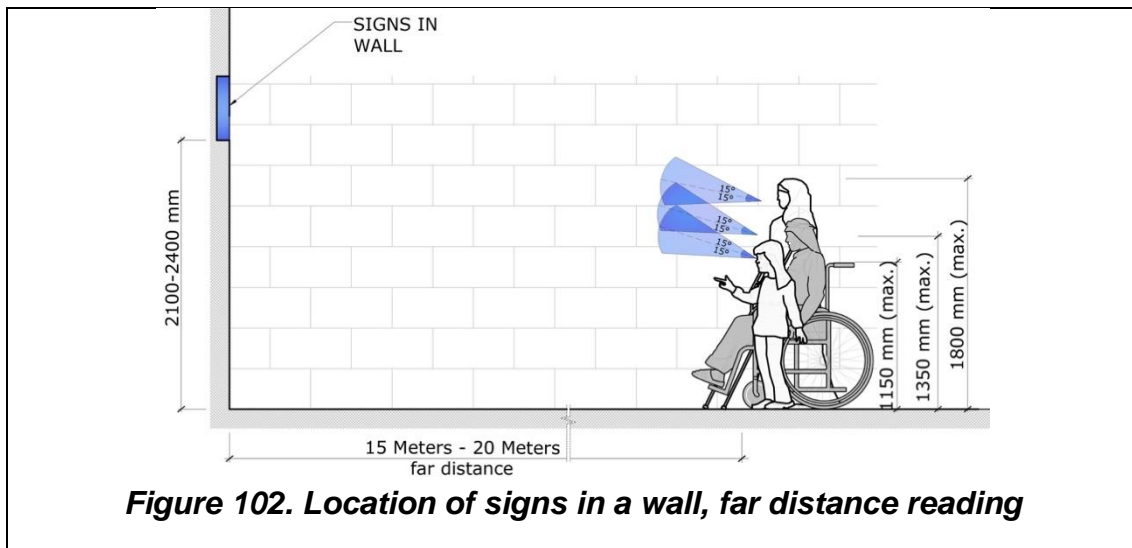
The following general design requirements shall be considered:

- e) Avoid visual clutter due to inappropriately designed or located signage and other elements in the environment.
- f) Colour coding should be used to differentiate zones or hierarchies of text messages. Colours that create confusion in case of colour blindness should be avoided.
- g) Standardised identification signs should be adopted to organise information in similar environments.
- h) Signage should be positioned at key decision-making points on the path of travel. It should be positioned over the accessible route at a height of at

- least 2200 mm, but in a manner that a person in a wheelchair or a child can see it easily. Signage should be positioned to avoid shaded areas and glare.
- i) Letters, numbers, symbols and pictographs should be glare-free and presented in high reflectance contrast.
  - j) Illuminated signs where the text is light on a dark background shall be avoided.
  - k) Printed characters shall be placed on top, centred (where there is only one word) and aligned to the left (when there is more than one word).
  - l) When both Arabic and English languages are used, Arabic being the primary language, texts shall be aligned to the right.
  - m) Safety and evacuation pictograms in workplaces and public places shall follow the ISO 3864-1 international standard.
  - n) Braille characters will be located at the bottom left, at a minimum distance of 10 mm and a maximum of 30 mm from the left side and bottom of the sign. Accessibility pictograms shall follow the ISO 7000 standard.
  - o) If signage is supplemented with Braille, it should be located at the bottom of the sign and presented in Grade One Braille that meets the standards in English.



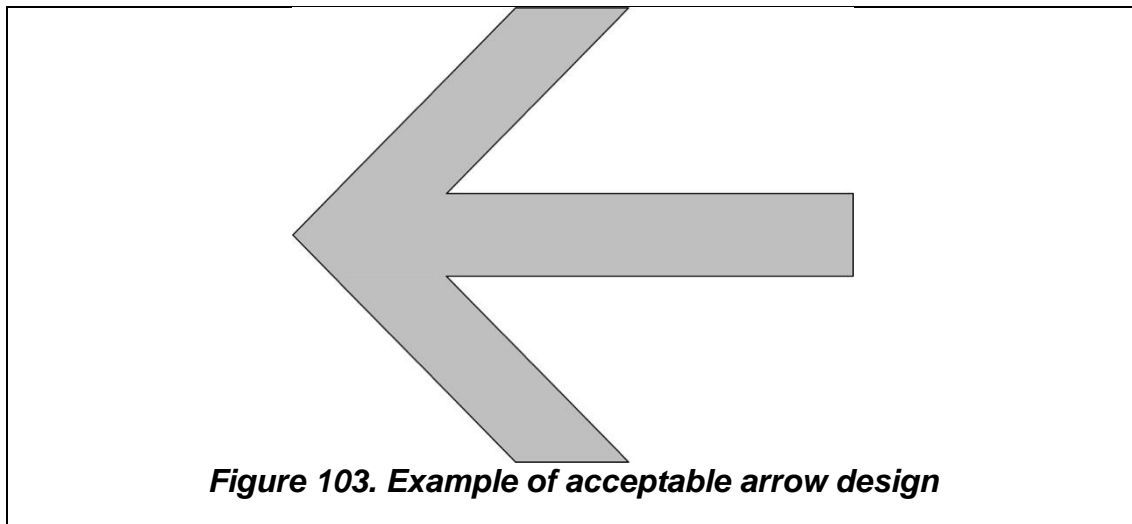




### 42.3 Directional signs

Directional signs shall give information to the users how to reach their destination. Arrows are essential for directional sign and should be used consistently in a building or facility throughout its system of signage.

An appropriate arrow design shall have the shaft longer than the header stem. The thickness shall be the same in all arrow lines and header lines shall have an angle of 45 degrees.















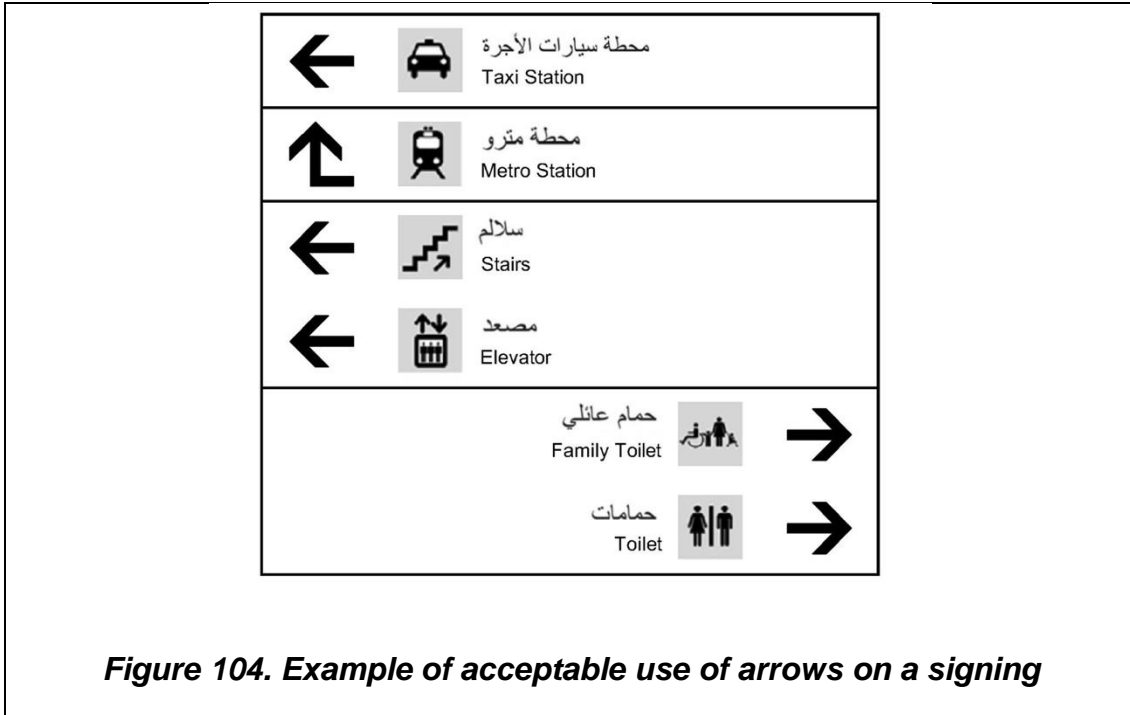
Arrow placement and pointing direction is also important for clarity and legibility. Arrows alignment in signs that includes a list of destinations depends on the direction they point out to, indicating the arrow alignment in the sign. The position of arrows in relation to the location name should correspond with the direction in which it is pointing. Therefore, when an arrow points to the left, it

should be placed to the left of the name and when an arrow points to the right, it should be placed on the right of the name

The following table shows the hierarchy of how to place and align arrows from the top to the bottom of a sign.

Table 6. Arrow alignment

Arrow alignment, typology and hierarchy			
Hierarchy	Arrows to be aligned on the left		Arrows to be aligned on the right
<b>Top of the sign</b>			Straight up 
		To the left, then ahead	To the right, then ahead 
		Ahead, then to the left	Ahead, then to the right 
		Go up on the left	Go up on the right 
		Turn left	Turn right 
		Go down on the left	Go down on the right 
<b>Bottom of the sign</b>			Go down ahead 

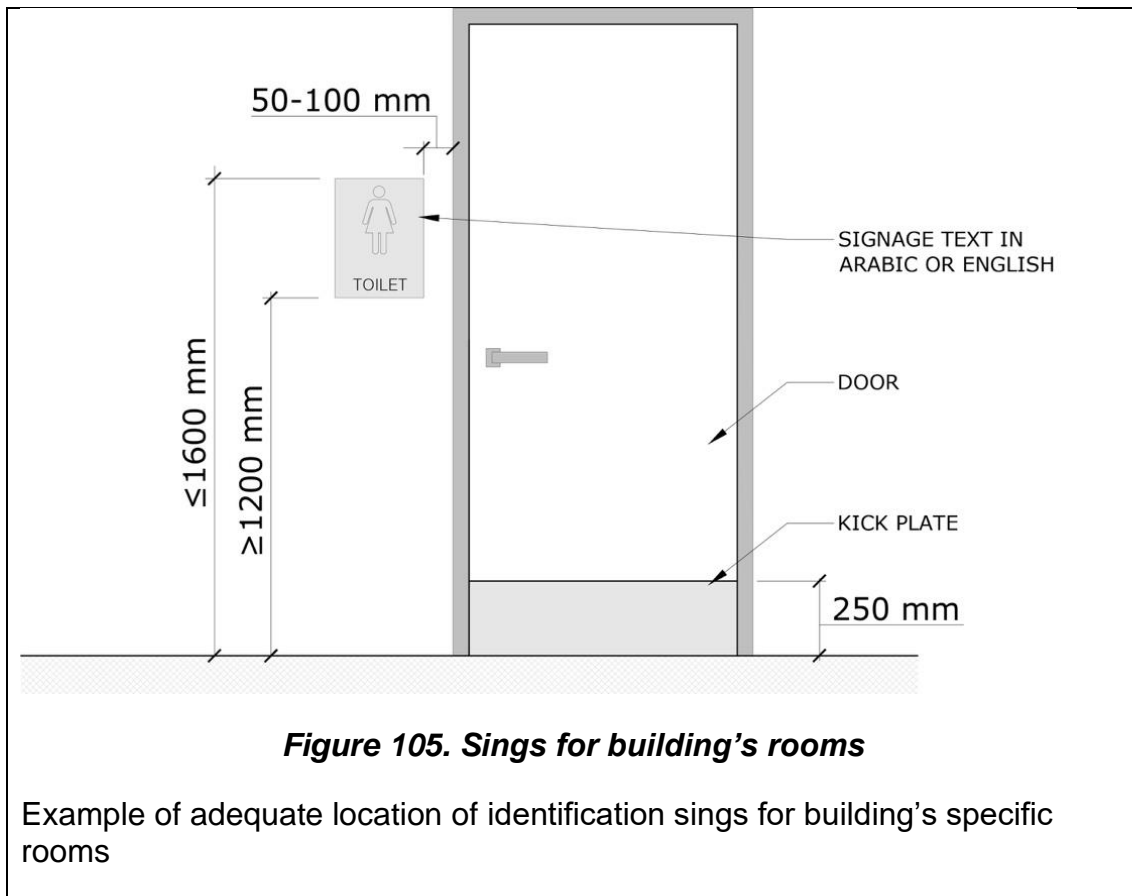


**Figure 104. Example of acceptable use of arrows on a signing**

#### 42.4 Identification signs

Identification signs are meant to identify a destination with the following characteristics:

- All building facades shall display the name of the building.
- All doorframes shall present information on the service(s) available in the space.
- Embossed standardized pictograms and text with contrasted colour must be used to identify the different services. Signage must be mounted at a height between 1200 mm and 1600 mm on the left of the door.



## 42.5 Tactile maps

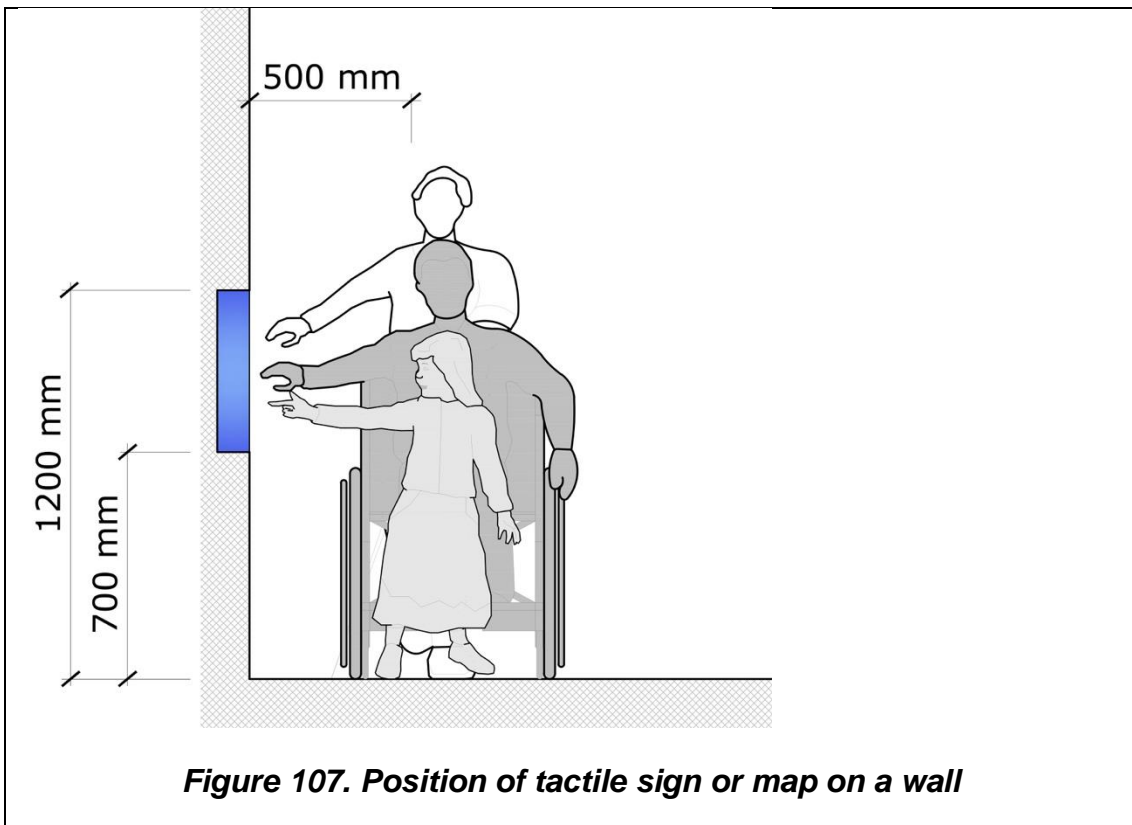
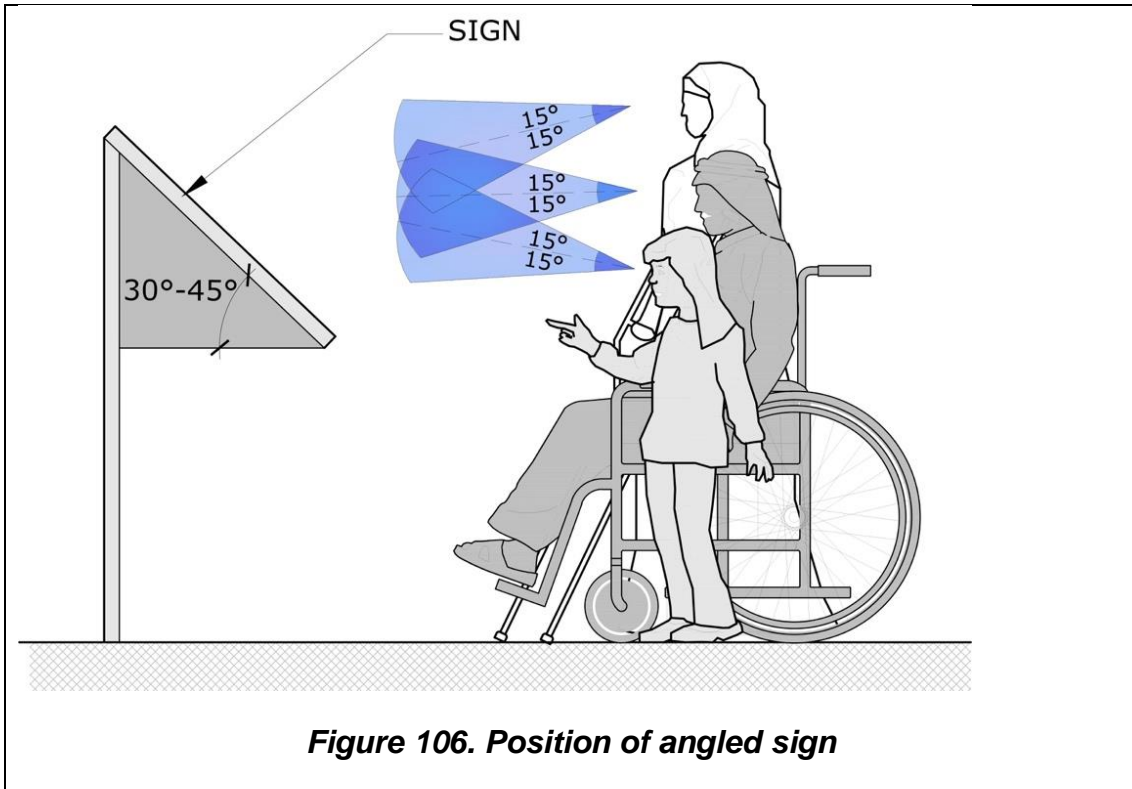
Tactile maps and models are an aid to orientation. They are particularly useful in large buildings, such as airports, visitor attractions and shopping malls.

Tactile maps or models shall represent the internal layout of a building by presenting a simple version of an image, in this case, a simplified version of the architectural plant, that a person touch to get a sense of the spaces distribution.

Tactile maps characteristics are:

- a) Tactile maps shall include only essential information: location of services, accessible routes and position of key elements such as entrances, emergency exits, information desk, main services, toilets, etc.
- b) Concepts used should be easy to understand, uncluttered and enabling a clear differentiation between lines, symbols, braille and other features.
- c) Graphic plane representation (lines, surfaces) should be defined through embossment, textures and colour contrasts.

- d) The signs and lettering of the map shall be represented with contrast between fonts and background colours. The font size shall be at least 20 mm in a sans serif typeface. The information shall also be in Braille system.
- e) The maximum dimensions of horizontal fixed tactile maps will be of 800 mm x 450 mm.
- f) The symbols should be clearly differentiated (form, colour and texture) and shall be easily associated with their representation.
- g) For complex layouts, buttons providing audible information shall be provided.
- h) When a tactile map is provided, it will be located within the accessible route and its location shall be indicated with a tactile warning surface. It should be in a well-lit area. Obstacles in front shall be avoided
- i) When they are mounted in busy public places, they shall include audible information.
- j) In large buildings and open spaces for public use (e.g. parks), they shall be located at the main entrance area, near the door, on the right side, within 1000 mm. In a building with more than one floor, it shall be located near the stairs or the elevator.
- k) When fixed to a vertical surface, it shall be centred between 1250 mm and 1750 mm above the floor. On horizontal or inclined surfaces, the height shall be between 900 mm and 1200 mm from the floor and the inclination will be between 30° and 45° from the horizontal level.



## 42.6 Typeface and lettering

In public spaces, internationally recognizable symbols are preferred instead of text. Symbols are a good option when using dual-language signs as they are easier and faster to recognize.

All relevant information should be provided in Arabic and English. When numerals are used, at least English numerals should be displayed.

Clarity and legibility are important. The English part of the signs should avoid the use of highly decorative, very bold, condensed typefaces, as they are difficult to understand.

Sans-serif fonts such as Arial, Tahoma, Verdana, Avenir and Avenir Heavy, Helvetica, Avant Gard, Future shall be used.

The use of a particular typeface should be consistent for all signage used within a building or facility. No more than 2 types of typefaces shall be used in a sign.

Wholly capitalised words should be avoided. Single words and short sentences should begin with a capital letter and continue with lower case letters.

Wording should be as simple as possible and single word or short sentences are preferred as they are easier to understand. The use of abbreviations should be avoided.

Only long texts should be aligned to the left in Latin languages and to the right in Arabic language. Short text can be centred.

Signs should present chromatic contrast with the surrounding environment and between the texts or icons and the sign background.

Signs shall avoid glare.

The distance at which a person can read the sign should be taken into account adjusting the font size according to the following table:

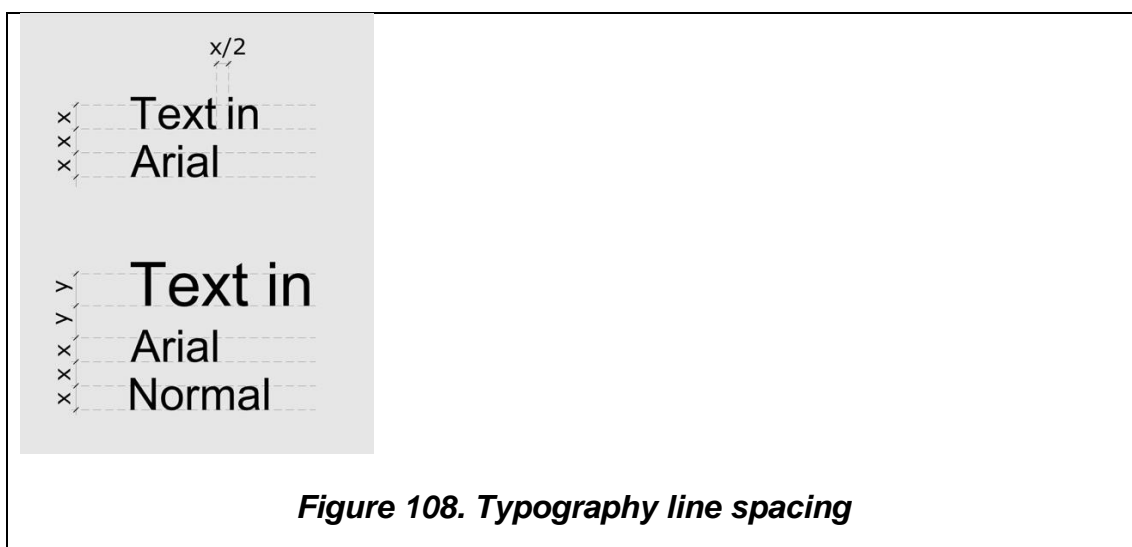


Table 7. Typography size

Signs font size according to reading distance		
Reading distance	Minimum size	Recommended size
≥50 meters	170 mm	200 mm
20 meters	140 mm	180 mm
5 meters	70 mm	140 mm
4 meters	56 mm	110 mm
3 meters	42 mm	84 mm
2 meters	28 mm	56 mm
1 meter	14 mm	28 mm
0.5 meters	7 mm	14 mm

Layout and line spacing shall fulfil the following criteria:

- Line spacing shall be identical to the height of the lowercase letters.
- When more than one letter size is used, the larger text height should be referenced to determine the line spacing between different letter sizes.
- Word spacing shall be a maximum of 0.5 times the height of the lower-case letters.



**Figure 108. Typography line spacing**

## 42.7 High embossment

When sign with tactile information are used, letters, numbers, symbols and pictographs should be raised at least 0.8 mm and should be between 16 mm and 50 mm high. If a tactile sign is mounted on a wall, its centre should be at a height between 700mm - 1200 mm from the floor level, as showed in Figure 107.

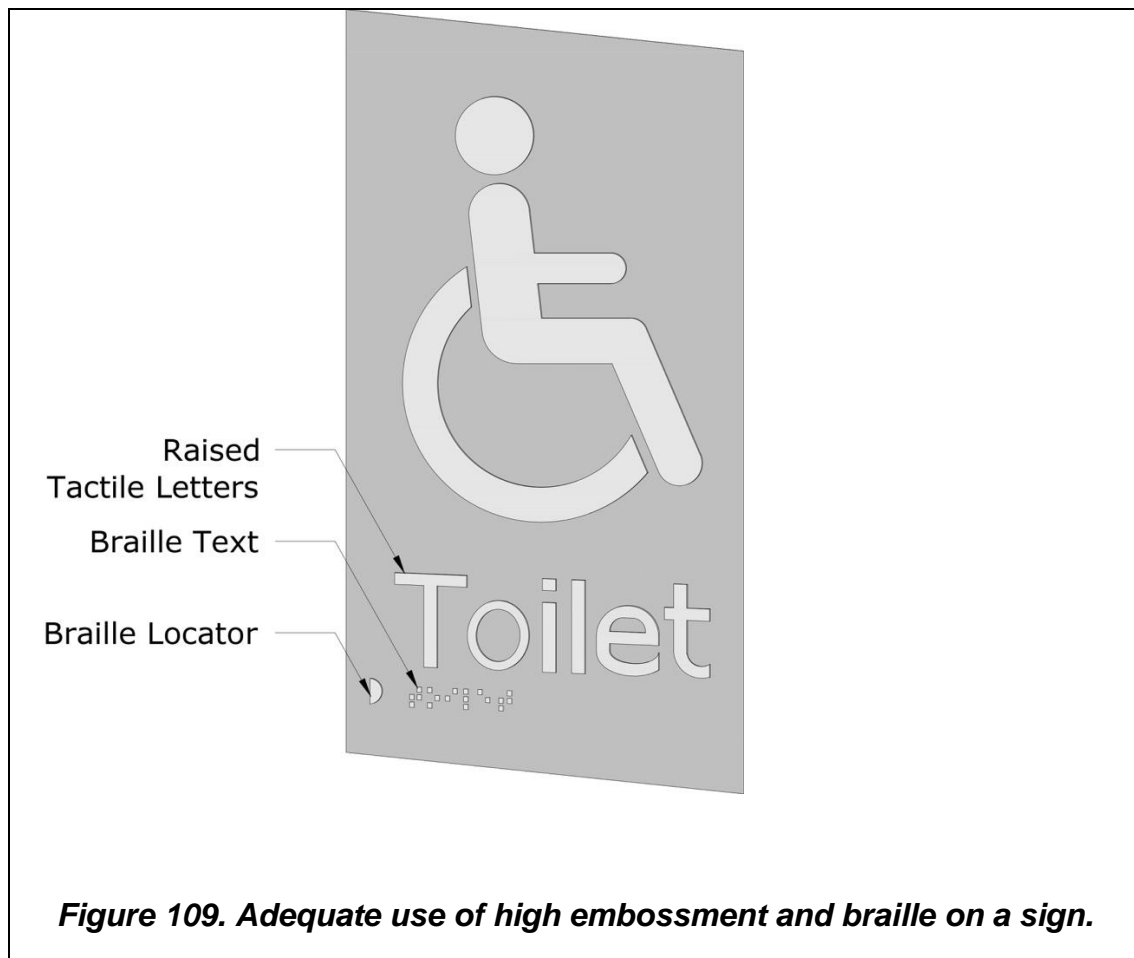
Long messages should be avoided for reading of letters and symbols in high embossment.

It should be used for rooms or spaces identification signs. These signs preferably represent a single icon or character; for example, the number of an elevator floor, restrooms icon, etc.

High embossment letters shall be in upper and lower case.

The tactile signs must be in high embossment and not engraved.

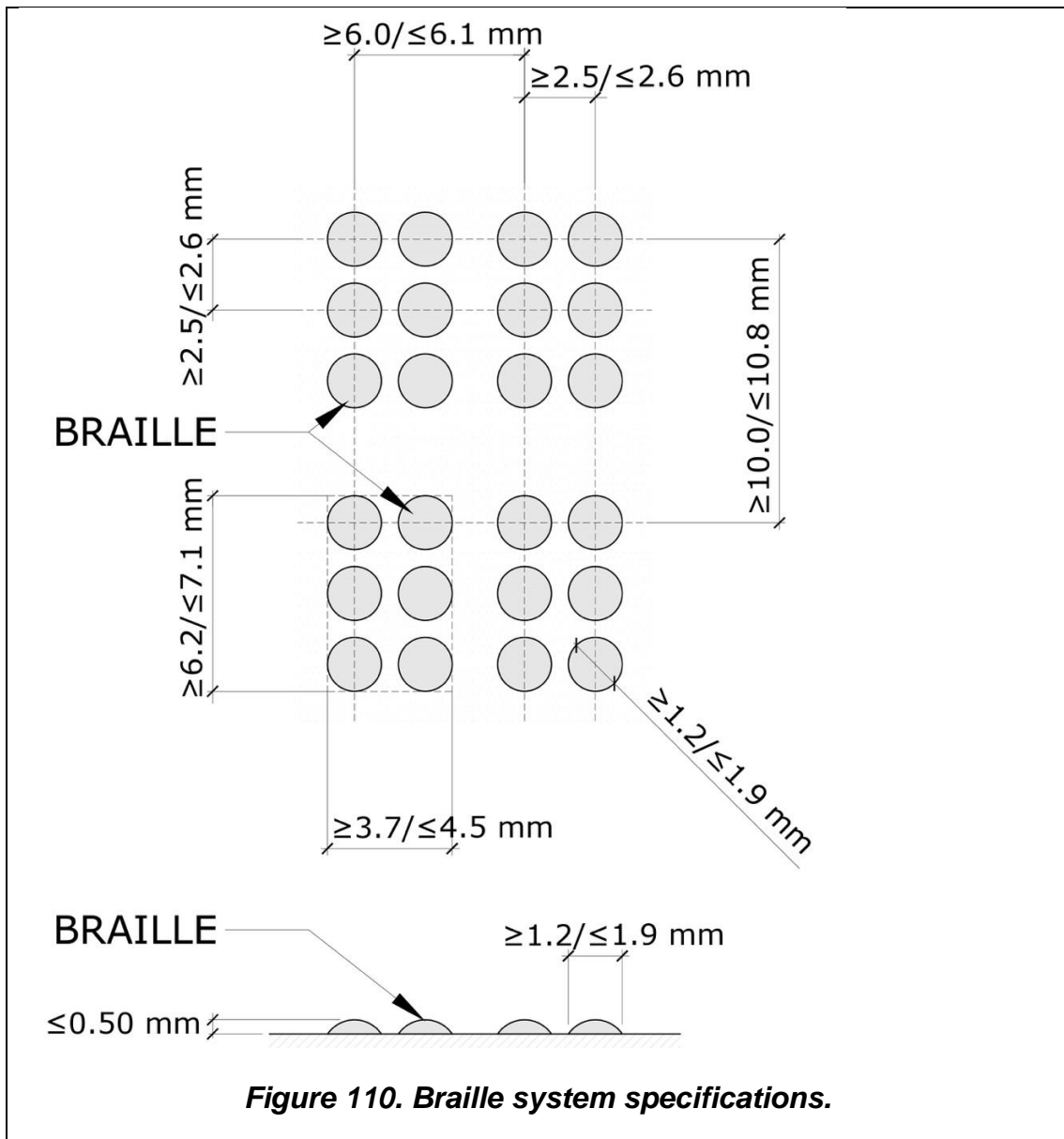
Symbol height shall not be less than 30 mm. The embossment thickness will be of between 2 mm and 5 mm for letters and of 2 mm for symbols.



## 42.8 Braille

### 42.8.1 Position

- a) Signs shall be mounted out of the accessible path and must not interfere with clear headroom along the entire path of at least 2200 mm.
- b) Place signs in consistent, predictable locations. Standardise the position of the same family of signs in the same areas of the environment.
- c) Signs shall be well illuminated at all times. Lighting and sun should not produce shadows or glare on the signs. For signs that are illuminated externally by ambient lighting, the preferred graphics is a dark colour against a light-coloured background.
- d) Avoid the backgrounds of signs in strong visual textures or that are reflective.
- e) Obstacles between signs and the observers shall be avoided.
- f) Signs in walls must be centred at a height of 1600 mm and the upper edge to a maximum height of 1750 mm above the ground. If mainly children use a space, a second level shall be installed, placing the second sign at a maximum height of 1250 mm.
- g) When the sign is mounted on a horizontal or inclined plane, inclination should be of between 30° and 45° from the horizontal level.
- h) Directional signs on a long route should be repeated sequentially starting from the decision-making point/junction, with a maximum spacing of 30 m. They serve as confirmation signs and repeater signs along the route.



**Figure 110. Braille system specifications.**

## 42.9 Accessible information means

Different means of providing simultaneous information to users should be used in a building, accommodating the preferences and characteristics of different type of users.

The combination of means to use depends on the specific building type, final users and type of information to be provided. Three types are commonly used for this purpose: audio, visual and tactile.

A common example is the use of audio and visual fire alarms, as specified in Section 43.4 of this Code, or the use of graphics and embossed symbols for signs, as specified in Section 42.7 of this Code.

The following table present examples of valid combinations for providing simultaneous information.

Table 8. Accessible communication combinations<sup>xv</sup>

Combination of communication channels				
Alphabetical writing and symbols	+	Tactile references / guiding tactile pavement		
Alphabetical writing and symbols	+	Alphabetical and symbolic embossed writing		
Alphabetical writing and symbols	+	Alphabetical and symbolic embossed writing	+	Braille
Alphabetical writing and symbols	+	Oral information		
Alphabetical writing	+	Braille		
Light signal	+	Simultaneous sound signal		
Oral Communication	+	Sign language/written text		

## 42.10 International symbol of access

The international symbol of access is intended to identify accessible features and facility used by persons with disabilities. However, in new, universally designed buildings, where most of the spaces and features are designed to be used by everybody, including persons with different disabilities, the symbol of access shall be used thoughtfully, preventing its overuse throughout any facilities.

The symbol of access shall be used in identity signs and directional signs, to guide users, especially where the location of any accessible element is not in the same place as the element to be used by non-disabled users, e.g. an accessible entrance in a retrofitted building that is not the same as the general entrance, or an accessible route in a facility with many path of travel options.

The international symbol specifications are dictated by the standard ISO 7001, and shall comply with the following:

- a) Two elements, a symbolised figure in a wheelchair and a plain square background.
- b) The symbolized figure shall face to the right.
- c) Proportions shall be in accordance with Figure 111 below.



**Figure 111. international Symbol of Access**

## 43 Emergency preparedness<sup>xvi</sup>

The procedures for evacuating a building should be posted, including evacuation procedures for persons with activity limitations.

Fire and life safety procedures should be posted in 14 pt. san serif font.

### 43.1 Fire evacuation for all

To protect people with activity limitations and/or people with impaired senses in a fire emergency, fire engineering design objectives should be developed.

The design objectives are:

- a) Protect people from fire in any of the following locations, when relevant:
  - In a place of safety, located a safe distance from a building, or a place of relative safety within a building, for example, an area of rescue assistance adjoining a vertical evacuation route;
  - During independent or assisted evacuation to a place of safety or a place of relative safety; and
  - In situ when no evacuation is possible, for example, in the case of health facilities, using small fire compartments.
- b) A building with an uncontrolled fire should remain structurally stable in every compartment or space where people remain, including:
  - People waiting in areas of rescue assistance or a place of relative safety;
  - People engaged in evacuation or providing assistance for assisted evacuation; and
  - People located in any space outside the building that would be threatened by structural collapse or in any space between the building and a place of safety.

Evacuation routes shall be available to all building users, with the following design principles:

- a) Protection and evacuation for all should be incorporated at a sufficiently early stage in the architectural design process.
- b) Vertical evacuation or evacuation to a place of safety, which will tend to be farther away than a place of relative safety, is more stressful than horizontal evacuation of areas as needed, particularly for people with mobility impairments;

- c) The fire engineering strategy needs to specify which occupants, based on abilities and other characteristics, are to be evacuated to a 'place of safety' and which to a 'place of relative safety';
- d) The fire engineering strategy needs to specify, based on fire size, location, and rate of growth, which areas are to be evacuated and when vertical evacuation is necessary;
- e) All elevators in new buildings should be capable of being used for people evacuation in a fire situation;
- f) Elevators in existing buildings, when being replaced or undergoing a major overhaul, should be made capable of being used for people evacuation in a fire situation

### **43.2 Areas of rescue assistance**

Independent evacuation may not be possible for all occupants, particularly in the case of existing buildings. For those occupants who need assisted evacuation, there should be a strategy for the provision of assisted evacuation, and there may need to be areas of rescue assistance.

An area of rescue assistance in a building should:

- a) Be provided on every floor of a building,
- b) Adjoin every evacuation staircase,
- c) Include space for persons in wheelchairs,
- d) Have good lighting and be clearly indicated with good signage,
- e) Be fitted with an accessible and reliable independent communication system fitted at a height of 800 mm to 1 100 mm above floor level, facilitating direct contact with a person in the designated control room for the building,
- f) Be of sufficient size for the storage of an evacuation chair and a manual fire alarm call point, a fire evacuation supply kit containing, for example, smoke hoods, suitable gloves to protect a person's hands from debris when pushing his/her manual wheelchair, etc.

### **43.3 Panic and emergency exit devices.**

- a) Release forces for panic exit devices operated by a horizontal bar for use on escape route require an operating force no greater than 220 N.



- b) Release forces for emergency exit devices operated by a lever handle shall be no greater than 70 N.
- c) Release forces for emergency exit devices operated by a push pad shall be no greater than 150 N

#### **43.4 Alarms**

- d) Audio and visual emergency alarms shall be provided throughout the building.
- e) Visual emergency alarms should have a flashing lights frequency of between two and four hertz. They shall be located in places where all building occupants can see them, including toilets, accessible toilets and family toilets. It is especially important to place visual alarms in locations where someone might be alone.
- f) Where two or more units may be viewed from a single area they should be synchronized
- g) Alarm signals louder than 120db should not be used.
- h) Fire detection and alarm systems that incorporate manual activation devices should be easy to operate and located within reach of all users.

#### **43.5 Evacuation devices**

Persons with activity limitations who are unable to evacuate independently may be evacuated with the assistance of an evacuation device or evacuation chair. Fire safety personnel can assist the person into the evacuation device and then take them down the stairs to a safe area.

Evacuation devices should be provided on every floor over one storey. The devices should be consistently located near the stairwell. Fire personnel should ensure that the building's users, including those with activity limitations, are trained on how to use evacuation devices.

Evacuation chairs should be capable of:

- a) Being safely and easily operated;
- b) Carrying people of high weight (up to 150 kg);
- c) Going up and down staircases;

- d) Compensating for any challenging features of a particular environment, such as narrow or unusually shaped staircases or evacuation paths over rough ground.

## 44 Management and maintenance<sup>xvii</sup>

The management and maintenance issues are important for providing an adequate accessibility level in a public building on a daily basis, for everyone.

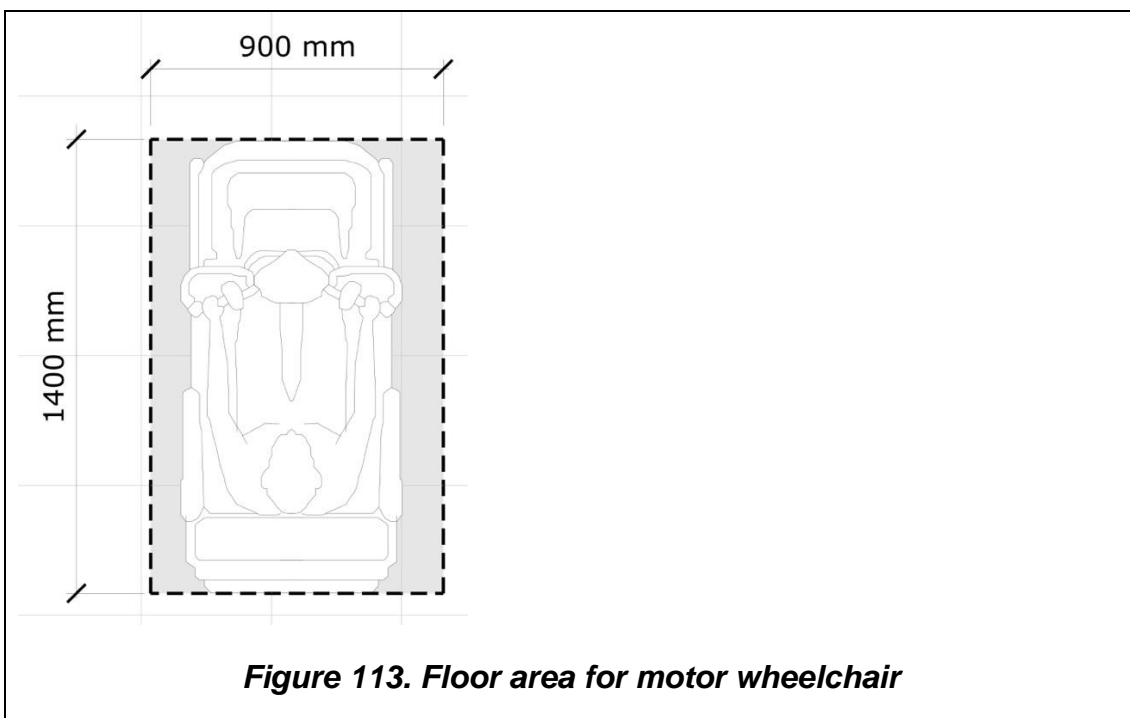
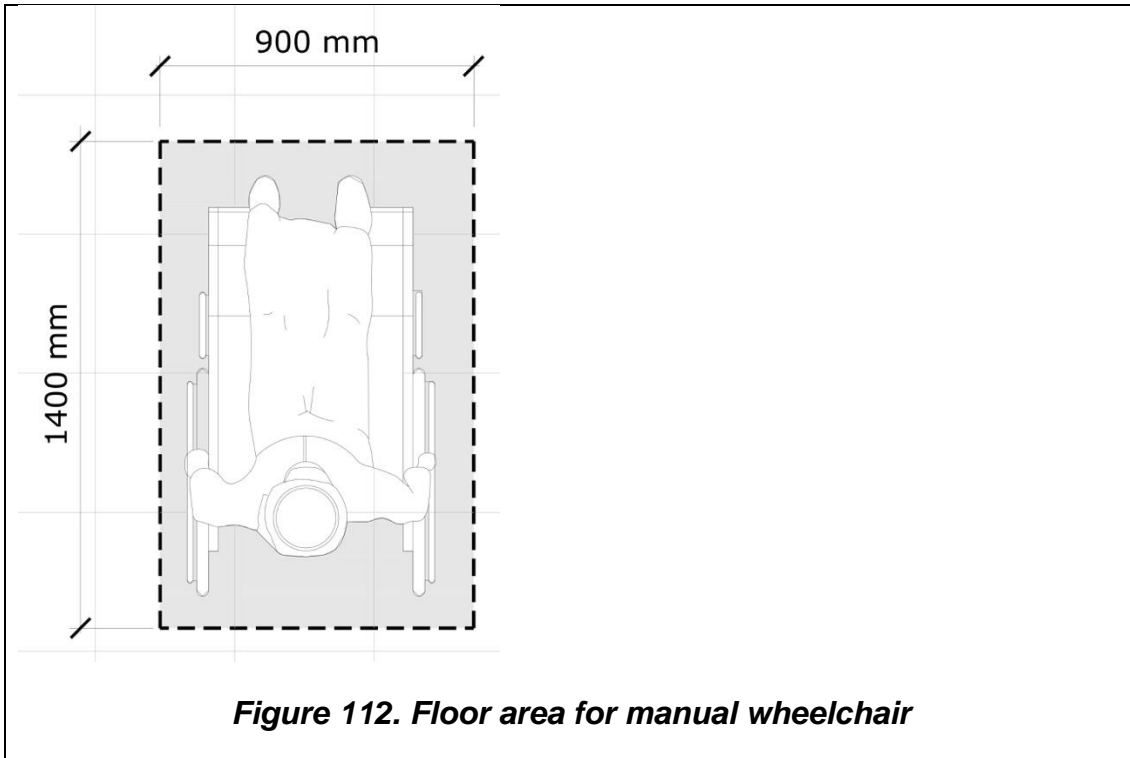
The following is a partial list of examples of items to be considered for maintaining an accessible environment. Depending on the type of building some of them may apply, and specific buildings or facilities may need additional measures.

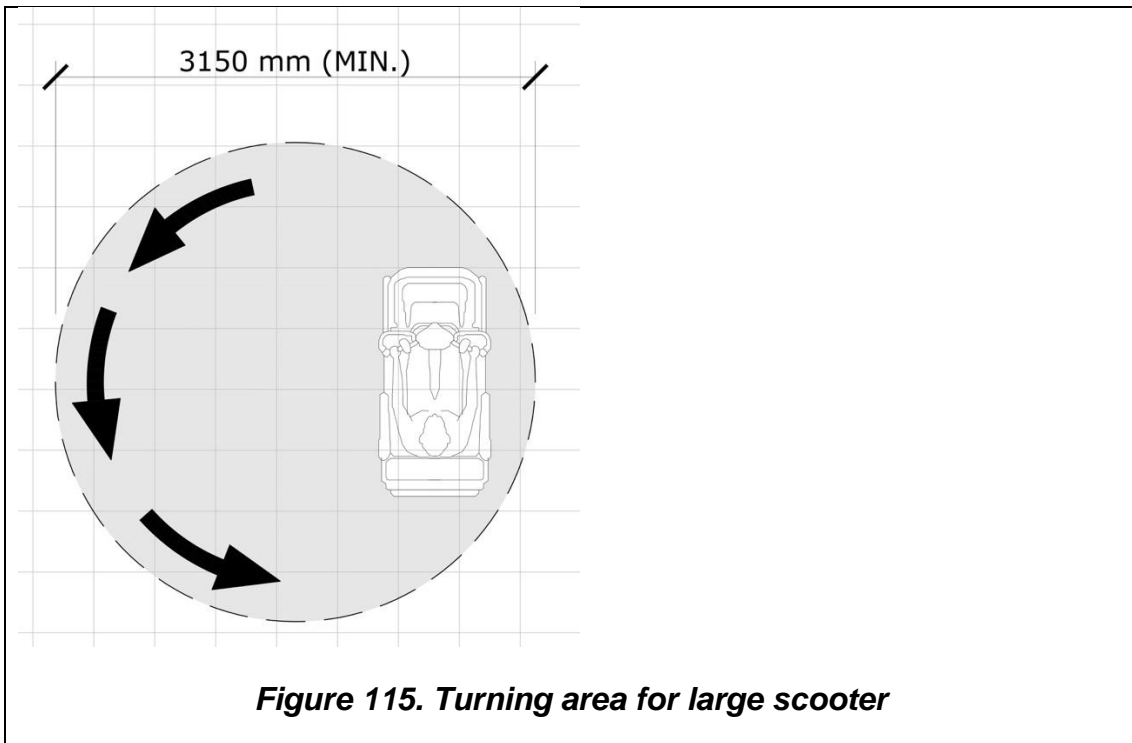
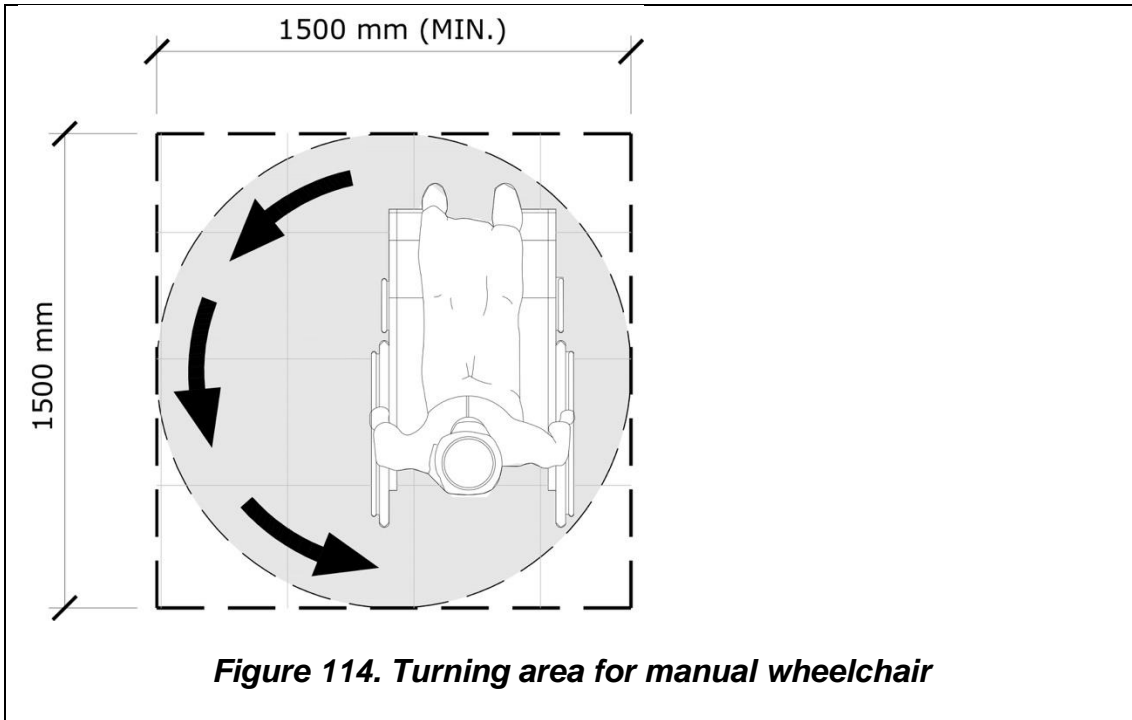
- a) Ensuring that responsibilities are defined within the organization, and instructing periodical accessibility audits.
- b) Training of staff regarding accessibility measures in the organization and reviewing all internal policies, procedures and practices.
- c) Ensuring that staff understand the management issues relating to disabled people, including emergency procedures.
- d) Keeping accessible routes, external and internal, including steps and ramps, clean, unobstructed and free of sand, water, debris, garbage, etc.
- e) Ensuring that designated accessible parking spaces are not being used by non-disabled motorists.
- f) Ensuring that wheelchair spaces are keep clear and available in seating areas.
- g) Ensuring that storage, planters, bins, etc., do not obstruct accessible routes, toilets, elevator call buttons or accessible controls of any kind in any room.
- h) Ensuring that trip hazards, such as at junctions between floor surfaces, are removed.
- i) Ensuring that, where floor sockets are provided (e.g. in meeting rooms), they don't constitute a trip hazard and that access to sockets is also available at desk level.
- j) Maintaining doors, door closers and building hardware, including checking that the opening forces of self-closing doors are within acceptable limits.
- k) Maintaining proper operation of access security systems.
- l) Checking floor surfaces, matting, surface-mounted carpets, etc., re-fixing to the floor where necessary, and replacing where damaged or worn.
- m) Ensuring that floors cleaning and polishing does not produce a slippery surface.

- n) Ensuring that entrances to prayer rooms provide shoes storage areas, for providing a clear access route.
- o) Maintaining proper operation of hearing enhancement systems, where provided.
- p) Maintaining sanitary rooms and accessories, including checking that toilet seats are securely fixed, cleaning tap nozzles to ensure correct water flow, functioning of sensor activated faucet, emptying and cleaning bins, and keeping equipment clean.
- q) Ensuring that a procedure is set up to respond to alarm calls from sanitary rooms.
- r) Ensuring that adjustable shower heads are lowered to be ready for the next user.
- s) Ensuring that emergency assistance pull cords are kept fully extended and in working order at all times, where provided
- t) Checking the mountings of all grab bars, and the mechanism of drop-down bars, re-fixing or replacing where necessary.
- u) Servicing of all types of lifts and elevators.
- v) Ensuring that facilities, such as lifts, elevators, etc., are in working order between servicing schedules, and providing alternative arrangements in case of facilities being out of order.
- w) Removing and/or changing signage as necessary, e.g. when departments relocate.
- x) Providing accurate information on facilities prior to arrival, e.g. on the building's or company's website.
- y) Providing audio description services.
- z) Providing all relevant literature, and reviewing/revising it when necessary.
- aa) Ensuring that a permanently manned position is available for the emergency elevators telephone communications.
- bb) Updating buildings maps and directories following changes.

## 45 Anthropometrics, acoustics and lighting

### 45.1 Dimensions and turning areas

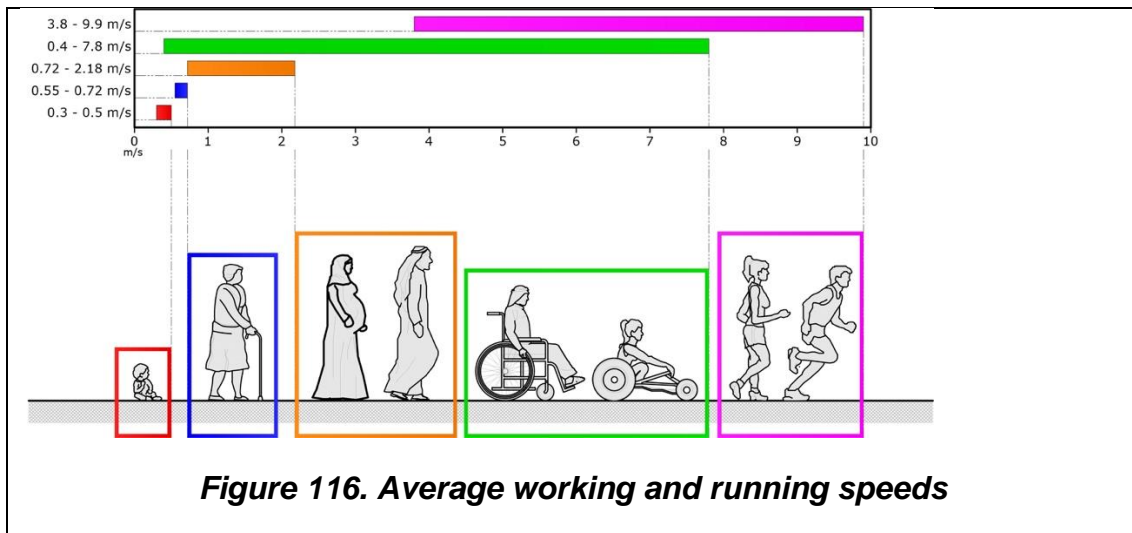




## 45.2 Walking and running speed<sup>xviii</sup>

Walking and running speeds are relevant when designing the green time for pedestrians in pedestrian crossings

The table below shows average speeds for walking and running, where the X axis represent the number of meters per second and the Y axis shows the average speed of different type of pedestrians.

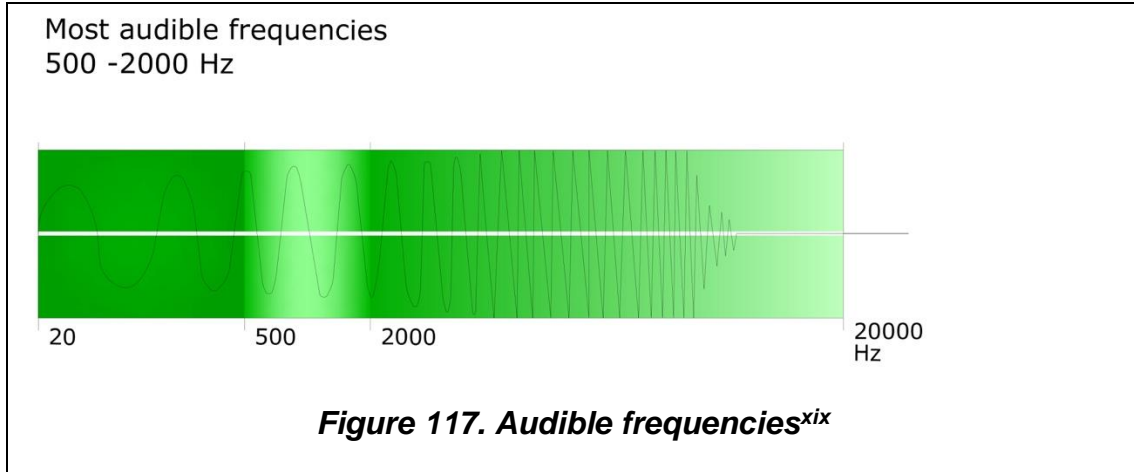


## 45.3 Acoustics

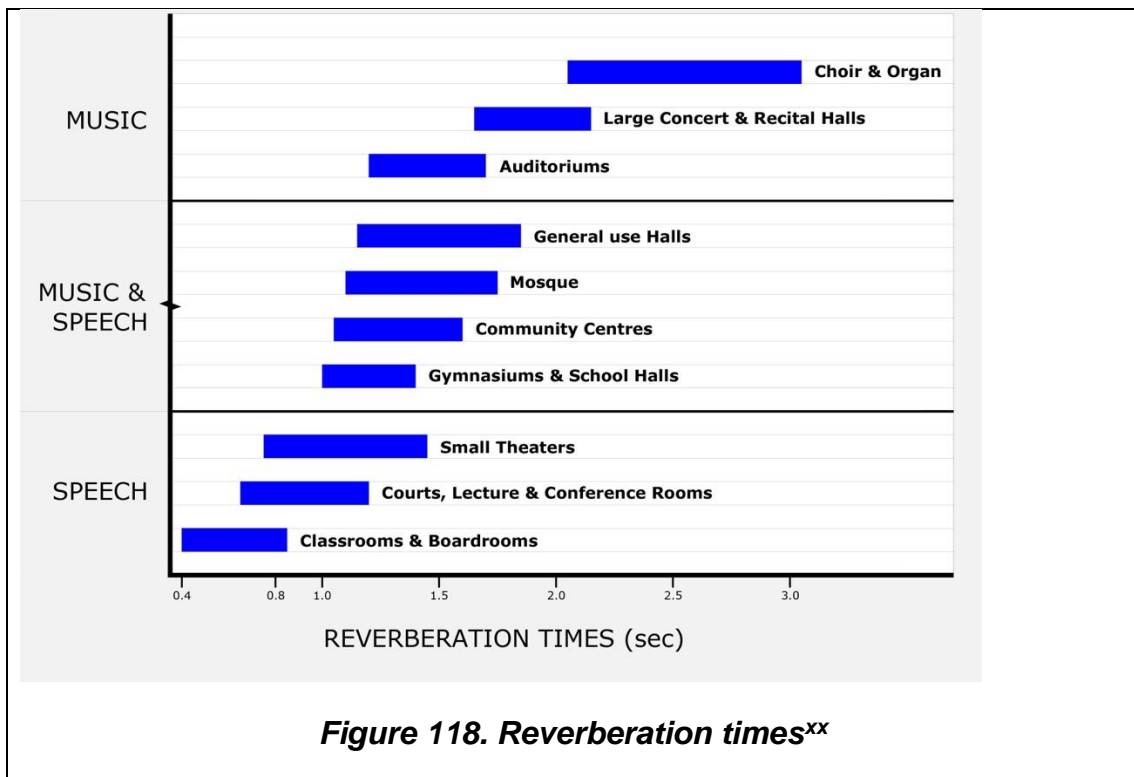
Acoustic plays an important role in accessible design, for blocking unwanted background noise or excessive reverberation. Good acoustic design also provides audible clues as a wayfinding feature. For that purpose, new designs shall:

- Consider the careful application of sound insulation and absorbing materials on ceilings, walls and floors for specific settings, including work environments, entertainment, meetings rooms.
- Acoustic performance of building materials, fabrics and furnishings shall be assessed for choosing the best possible acoustic environments.
- Providing appropriate sound clues along accessible routes and at destination points, as part of the wayfinding design. This can be achieved by combining the type of materials used in floors to provide acoustic differences between the floor used in the accessible route and adjacent areas, placing fountains or any other architectural element that help differentiate between spaces for its acoustic properties.

Audible communication in the range of 500-2.000 Hz should be favoured in acoustic signals, alarms and voice messages in Public Announcement Systems and shall be considered when providing audio messages,



Optimum reverberation time vary according to the room's intended use. To ensure a good acoustic design on specific rooms, when choosing materials for interior designs, acoustic reverberation levels shall fulfil the requirements of the following table:





## 45.4 Lighting

General lighting in buildings shall be controllable, whether natural or artificial.

Windows and light fittings locations should avoid glare.

The provision of blinds, dimmer switches or computer controlled lighting systems should be considered.

Colour temperature of artificial lighting should match that of daylight where possible.

Lighting controls shall comply with Section 40.

## 46 Table of figures

<b>Figure 1. Unobstructed widths.....</b>	<b>17</b>
<b>Figure 2. Grates in accessible routes.....</b>	<b>18</b>
<b>Figure 3. Clear width street furniture with grilles.....</b>	<b>18</b>
<b>Figure 4. Accessible path with resting area example. ....</b>	<b>19</b>
<b>Figure 5. Kerb ramp with flared sides .....</b>	<b>23</b>
<b>Figure 6. Single slope kerb ramp.....</b>	<b>24</b>
<b>Figure 7. Kerb ramp in kerb extensions.....</b>	<b>25</b>
<b>Figure 8. Lowered sidewalks to road level.....</b>	<b>26</b>
<b>Figure 9. Elevated sidewalk.....</b>	<b>27</b>
<b>Figure 10. Intermediate island for different green light cycles.....</b>	<b>29</b>
<b>Figure 11. Intermediate island.....</b>	<b>29</b>
<b>Figure 12. Barriers in garage entryways .....</b>	<b>31</b>
<b>Figure 13. Accessible garage access .....</b>	<b>32</b>
<b>Figure 14. Accessible garage access .....</b>	<b>32</b>
<b>Figure 15. Pick-up area with kerb ramp.....</b>	<b>33</b>
<b>Figure 16. Pick-up area with no level difference.....</b>	<b>33</b>
<b>Figure 17. Accessible angled parking spaces specifications .....</b>	<b>35</b>
<b>Figure 18. Accessible perpendicular spaces specifications .....</b>	<b>36</b>
<b>Figure 19. Accessible parallel parking place along the sidewalk .....</b>	<b>37</b>
<b>Figure 20. Accessible parking sign .....</b>	<b>37</b>
<b>Figure 21. Example of accessible route .....</b>	<b>39</b>
<b>Figure 22. Example of accessible security barriers .....</b>	<b>39</b>
<b>Figure 23. Clear accessible area on seating spaces .....</b>	<b>41</b>
<b>Figure 24. Protruding objects.....</b>	<b>44</b>
<b>Figure 25. Revolving doors shall have an alternative accessible door .....</b>	<b>45</b>

<b>Figure 26. Height of door handle .....</b>	<b>47</b>
<b>Figure 27. Door Hardware.....</b>	<b>47</b>
<b>Figure 28. Clear spaces for one push side swinging doors .....</b>	<b>48</b>
<b>Figure 29. Door clear spaces .....</b>	<b>49</b>
<b>Figure 30. Door clear spaces .....</b>	<b>49</b>
<b>Figure 31. Angled doors in a series.....</b>	<b>50</b>
<b>Figure 32. Marks on glass doors or surfaces .....</b>	<b>52</b>
<b>Figure 33. Use of glass marks on a building entrance.....</b>	<b>52</b>
<b>Figure 34. Window height with fixed glass .....</b>	<b>53</b>
<b>Figure 35. Use of railing and grab bars .....</b>	<b>55</b>
<b>Figure 36. Handrails profile .....</b>	<b>55</b>
<b>Figure 37. Handrails' gripping area .....</b>	<b>56</b>
<b>Figure 38. Handrail's distance to wall .....</b>	<b>56</b>
<b>Figure 39. Railing and grab bars in ramps.....</b>	<b>57</b>
<b>Figure 40. Tactile information on handrails .....</b>	<b>57</b>
<b>Figure 41. Detectable warning surface specifications .....</b>	<b>60</b>
<b>Figure 42. Tactile guiding surface specifications.....</b>	<b>61</b>
<b>Figure 43. Example of tactile surfaces use .....</b>	<b>62</b>
<b>Figure 44. Example of tactile surfaces use .....</b>	<b>63</b>
<b>Figure 45. Elevator specifications .....</b>	<b>66</b>
<b>Figure 46. Elevator buttons layout.....</b>	<b>67</b>
<b>Figure 47. Specifications for non-enclosed platforms.....</b>	<b>68</b>
<b>Figure 48. Colour contrast specifications for ramps .....</b>	<b>71</b>
<b>Figure 49. Location of warning surfaces in ramp's landings .....</b>	<b>71</b>
<b>Figure 50. Ramp specifications.....</b>	<b>72</b>
<b>Figure 51. Combined use of ramps and stairs.....</b>	<b>73</b>

<b>Figure 52. Ramps' handrails specifications.....</b>	<b>73</b>
<b>Figure 53. Intersection of ramp and corridor.....</b>	<b>74</b>
<b>Figure 54. Clear space between ramp and doors.....</b>	<b>74</b>
<b>Figure 55. No open risers are allowed.....</b>	<b>75</b>
<b>Figure 56. Steps specifications.....</b>	<b>76</b>
<b>Figure 57. Stairs single flight specifications.....</b>	<b>77</b>
<b>Figure 58. Stairs, multiple flights specifications.....</b>	<b>78</b>
<b>Figure 59. Clear space below stairs.....</b>	<b>79</b>
<b>Figure 60. Accessible urinals.....</b>	<b>81</b>
<b>Figure 61. Toilet seat specifications.....</b>	<b>82</b>
<b>Figure 62. Type A individual toilet.....</b>	<b>84</b>
<b>Figure 63. Type B individual toilet.....</b>	<b>85</b>
<b>Figure 64. Accessible washbasin.....</b>	<b>86</b>
<b>Figure 65. Height of controls and accessories in toilets.....</b>	<b>87</b>
<b>Figure 66. Toilet room's door.....</b>	<b>88</b>
<b>Figure 67. Accessible shower seat.....</b>	<b>90</b>
<b>Figure 68. Accessible family toilet.....</b>	<b>92</b>
<b>Figure 69. Feeding room option A.....</b>	<b>93</b>
<b>Figure 70. Feeding room option A, elevation.....</b>	<b>94</b>
<b>Figure 71. Feeding room option B.....</b>	<b>94</b>
<b>Figure 72. Accessible ablution space layout.....</b>	<b>96</b>
<b>Figure 73. Accessible washbasin for ablution areas.....</b>	<b>96</b>
<b>Figure 74. Accessible chair with clear space.....</b>	<b>97</b>
<b>Figure 75. Accessible bench with clear space.....</b>	<b>98</b>
<b>Figure 76. Accessible table or desk.....</b>	<b>98</b>
<b>Figure 77. Accessible drinking fountain.....</b>	<b>99</b>

<b>Figure 78. Accessible vending /auto-pay machine.....</b>	<b>101</b>
<b>Figure 79. Auditorium and theatre accessible seating layout.....</b>	<b>105</b>
<b>Figure 80. Accessible hotel rooms .....</b>	<b>108</b>
<b>Figure 81. Accessible bathroom with bathtub.....</b>	<b>109</b>
<b>Figure 82. Accessible shower, transfer space in both sides.....</b>	<b>109</b>
<b>Figure 83. Accessible shower, transfer space in one sides .....</b>	<b>110</b>
<b>Figure 84. Clear space around tables.....</b>	<b>112</b>
<b>Figure 85. Clear space in kitchens.....</b>	<b>112</b>
<b>Figure 86. Meeting or interview room.....</b>	<b>113</b>
<b>Figure 87. Minimum width for a checkout lane.....</b>	<b>114</b>
<b>Figure 88. Location of accessible lockers .....</b>	<b>115</b>
<b>Figure 89. Maximum threshold rise .....</b>	<b>117</b>
<b>Figure 90. Accessible beach layout.....</b>	<b>119</b>
<b>Figure 91. Accessible beach with access to water.....</b>	<b>119</b>
<b>Figure 92. Accessible commercial kiosk.....</b>	<b>120</b>
<b>Figure 93. Access to swimming pools, option A .....</b>	<b>122</b>
<b>Figure 94. Access to swimming pools, option B .....</b>	<b>122</b>
<b>Figure 95. Accessible shower layout.....</b>	<b>123</b>
<b>Figure 96. Height for controls and operating mechanisms .....</b>	<b>124</b>
<b>Figure 97. Accessible route on construction sites.....</b>	<b>127</b>
<b>Figure 98. Alternate accessible route.....</b>	<b>127</b>
<b>Figure 99. Accessible route on scaffolding installations .....</b>	<b>128</b>
<b>Figure 100. Signage along a pedestrian path .....</b>	<b>132</b>
<b>Figure 101. Location of signs in a wall, close distance reading .....</b>	<b>132</b>
<b>Figure 102. Location of signs in a wall, far distance reading.....</b>	<b>133</b>
<b>Figure 103. Example of acceptable arrow design.....</b>	<b>133</b>

<b>Figure 104. Example of acceptable use of arrows on a signing.....</b>	<b>135</b>
<b>Figure 105. Signs for building's rooms .....</b>	<b>136</b>
<b>Figure 106. Position of angled sign.....</b>	<b>138</b>
<b>Figure 107. Position of tactile sign or map on a wall .....</b>	<b>138</b>
<b>Figure 108. Typography line spacing .....</b>	<b>140</b>
<b>Figure 109. Adequate use of high embossment and braille on a sign. ...</b>	<b>141</b>
<b>Figure 110. Braille system specifications. ....</b>	<b>143</b>
<b>Figure 111. international Symbol of Access .....</b>	<b>145</b>
<b>Figure 112. Floor area for manual wheelchair .....</b>	<b>152</b>
<b>Figure 113. Floor area for motor wheelchair.....</b>	<b>152</b>
<b>Figure 114. Turning area for manual wheelchair .....</b>	<b>153</b>
<b>Figure 115. Turning area for large scooter .....</b>	<b>153</b>
<b>Figure 116. Average working and running speeds.....</b>	<b>154</b>
<b>Figure 117. Audible frequencies .....</b>	<b>155</b>
<b>Figure 118. Reverberation times.....</b>	<b>155</b>

## 47 Bibliography

- ADA Standards for Accessible Design. USA
- Australian Government/Ausaid. Accessibility Design Guide: Universal design principles for Australia's aid program
- British Standard 8300, Design of buildings and their approaches to meet the needs of disabled people – Code of practice.
- Canadian Standards Association, B651, Accessible design for the built environment.
- Dubai Universal Design Code. UAE
- International Standards Organization. ISO 21542, Building construction- Accessibility and usability of the built environment.
- Kuwait's Persons with Disabilities' Code.
- Kuwait's Public Authority of the Disabled Strategic Plan.
- Kuwait's Strategy for Implementing Universal Code for Disabled.
- Mexico City Government/SEDUVI. Manual de Normas Técnicas de Accesibilidad 2016.
- National Disability Authority, et al. Building for Everyone: A Universal Design Approach. Ireland.
- Organización Nacional de Ciegos de España. Accesibilidad para personas con ceguera y deficiencia visual. Spain
- The Code on Accessibility in the Built environment – Singapore.
- Universal Accessibility – Built Environment Guidelines for the Kingdom of Saudi Arabia.
- Wayfinding Singapore Standard SS 599-2014.

## 48 Notes

---

- <sup>i</sup> Specifications according to The Dubai Universal Design Code
- <sup>ii</sup> According to specifications of the ISO Standard 21542
- <sup>iii</sup> Specifications and figures adapted from the Dubai Universal Design Code
- <sup>iv</sup> The specifications for this section has been adapted from the ISO Standard 21542 and the Dubai Universal Design Code. Illustrations and tactile pavement measurements are according to the Dubai Universal Design Code.
- <sup>v</sup> According to The Dubai Universal Design Code
- <sup>vi</sup> Adapted from UK's BS8300 and the Mexico City/Seduvi Accessibility Guidelines
- <sup>vii</sup> According to ISO Standard 21542
- <sup>viii</sup> The specifications for this section have been adapted from several codes and the figures have been adapted to match The Dubai Universal Design Code.
- <sup>ix</sup> The figures in this section has been adapted from The Dubai Universal Design Code.
- <sup>x</sup> Adapted from the Dubai Universal Design Code.
- <sup>xi</sup> Specifications and figures adapted from the Built Environment Guidelines for the Kingdom of Saudi Arabia and the Dubai Universal Design Code.
- <sup>xii</sup> Specifications adapted from the Built Environment Guidelines for the Kingdom of Saudi Arabia and the Dubai Universal Design Code.
- <sup>xiii</sup> Adapted from the Dubai Universal Design Code.
- <sup>xiv</sup> This section has been developed according to specifications from the following standards and guidelines: ISO Standard 21542, Singapore Standard SS 599-2014 and the Dubai Universal Design Code
- <sup>xv</sup> According to The Dubai Universal Design Code
- <sup>xvi</sup> This section has been developed according to specifications from the following standards and guidelines: ISO Standard 21542, Building for Everyone: A Universal Design Approach; The Dubai Universal Design Code
- <sup>xvii</sup> This section has been adapted from the ISO Standard 21542, the Irish Universal Design Booklets
- <sup>xviii</sup> According to specifications from the Dubai Universal Design Code
- <sup>xix</sup> Ibidem
- <sup>xx</sup> Ibidem

Kuwait Universal Design Code developed by:  
Taghreed Zuhair Al-Zubaidi  
Andres Balcazar de la Cruz

Drawings by:  
Meeza Lapac

Cover image credit: Istock/Katerina Andronchik